

KENWOOD

INSTRUCTION MANUAL



144/ 220/ 440 MHz FM TRIBANDER

TH-F6A

144/ 430 MHz FM DUAL BANDER

TH-F7E

KENWOOD CORPORATION

© B62-1441-00 (K,E,T)
09 08 07 06 05 04 03 02 01 00

MODELS COVERED BY THIS MANUAL

The models listed below are covered by this manual.

TH-F6A: 144/ 220/ 440 MHz FM Tri-band
Portable Transceiver

TH-F7E: 144/ 430 MHz FM Dual-band
Portable Transceiver

MARKET CODES

K-type: The Americas

E-type: Europe/ General

T-type: The United Kingdom

The market code is shown on the carton box.

Refer to the specifications {pages 53, 54} for the information on available operating frequencies within each model.

NOTICE TO THE USER

One or more of the following statements may be applicable for this equipment.

FCC WARNING

This equipment generates or uses radio frequency energy. Changes or modifications to this equipment may cause harmful interference unless the modifications are expressly approved in the instruction manual. The user could lose the authority to operate this equipment if an unauthorized change or modification is made.

INFORMATION TO THE DIGITAL DEVICE USER REQUIRED BY THE FCC

This equipment has been tested and found to comply with the limits for a Class B digital device, pursuant to Part 15 of the FCC Rules. These limits are designed to provide reasonable protection against harmful interference in a residential installation.

This equipment generates, uses and can generate radio frequency energy and, if not installed and used in accordance with the instructions, may cause harmful interference to radio communications. However, there is no guarantee that the interference will not occur in a particular installation. If this equipment does cause harmful interference to radio or television reception, which can be determined by turning the equipment off and on, the user is encouraged to try to correct the interference by one or more of the following measures:

- *Reorient or relocate the receiving antenna.*
- *Increase the separation between the equipment and receiver.*
- *Connect the equipment to an outlet on a circuit different from that to which the receiver is connected.*
- *Consult the dealer for technical assistance.*

PRECAUTIONS

Please observe the following precautions to prevent fire, personal injury, or transceiver damage:

- Do not transmit with high output power for extended periods. The transceiver may overheat.
- Do not modify this transceiver unless instructed by this manual or by **KENWOOD** documentation.
- When using a regulated power supply, connect the specified DC cable (option) to the DC IN jack on the transceiver. The supply voltage must be between 12 V and 16 V to prevent damaging the transceiver.
- When connecting the transceiver to a cigarette lighter socket in a vehicle, use the specified cigarette lighter cable (option).
- Do not expose the transceiver to long periods of direct sunlight nor place the transceiver close to heating appliances.
- Do not place the transceiver in excessively dusty areas, humid areas, wet areas, nor on unstable surfaces.
- If an abnormal odor or smoke is detected coming from the transceiver, turn OFF the power immediately and remove the battery case or the battery pack from the transceiver. Contact your authorized **KENWOOD** dealer, customer service, or service station.

THANK YOU

Thank you for choosing this **KENWOOD** TH-F6A/ TH-F7E transceiver. It has been developed by a team of engineers determined to continue the tradition of excellence and innovation in **KENWOOD** transceivers.

First, don't let the size fool you. This small FM portable transceiver features 2 m, 1.25 m (TH-F6A only), and 70 cm amateur radio band operation plus another all-mode 100 kHz to 1.3 GHz receiver (SSB and CW are up to 470 MHz). In the meantime, as you learn how to use this transceiver, you will also find that **KENWOOD** is pursuing "user friendliness". For example, each time you change the Menu No. in Menu mode, you will see a text message on the display that lets you know what you are configuring.

Though user friendly, this transceiver is technically sophisticated and some features may be new to you. Consider this manual to be a personal tutorial from the designers. Allow the manual to guide you through the learning process now, then act as a reference in the coming years.

FEATURES

- Ultra compact design
- 2 m, 1.25 m (TH-F6A only), and 70 cm amateur radio band FM transceiver operation
- A separate wide band, all-mode receiver, built-in
- Dual-frequency receive within the same amateur radio bands
- 400 memory channels plus 34 special function memory channels (35 channels for TH-F6A)
- Long operation period with a Li-ion battery pack
- High output power (up to 5 W operation)
- Easy to control and select various functions with Multi-scroll key
- 9600 bps Packet-ready data (Speaker/ Mic.) jack
- Built-in VOX function
- Meets MIL-STD 810C/ D/ E, Rain, Humidity, Vibration, and Shock

SUPPLIED ACCESSORIES

After carefully unpacking the transceiver, identify the items listed in the table below. We recommend you keep the box and packing material in case you need to repack the transceiver in the future.

Accessory	Part Number	Quantity		
		TH-F6A (K)	TH-F7E	
			(E)	(T)
Belt hook	J29-0623-XX	1	1	1
Antenna	T90-0781-XX	1	–	–
	T90-0789-XX	–	1	1
Strap	J69-0342-XX	1	1	1
Line Filter	L79-1417-XX	–	1	1
Li-ion battery	W09-0979-XX	1	1	1
Charger	W08-0927-XX	1	–	–
	W08-0928-XX	–	1	–
	W08-0929-XX	–	–	1
Instruction Manual	B62-1441-XX (E/ S)	1	1	1
	B62-1442-XX (F/ I)	–	1	–
	B62-1443-XX (D/ G)	–	1	–
R&TTE Notice	B59-2267-XX	–	1	1
Warranty card	—	1	1	1

WRITING CONVENTIONS FOLLOWED

The writing conventions described below have been followed to simplify instructions and avoid unnecessary repetition.

Instruction	What to Do
Press [KEY] .	Press and release KEY .
Press [KEY1] , [KEY2] .	Press KEY1 momentarily, release KEY1 , then press KEY2 .
Press [KEY] (1 s).	Press and hold KEY down for a second.
Press [KEY1]+[KEY2] .	Press and hold KEY1 down, then press KEY2 . If there are more than two keys, press and hold down each key in turn until the final key has been pressed.
Press [KEY]+[⏻] .	With the transceiver OFF, press and hold KEY , then switch ON the transceiver power by pressing [⏻] (POWER).

Since the amateur radio bands are slightly different from country to country, the following meter band descriptions are used in this manual.

- 2 m band : 144 ~ 148 MHz or 144 ~ 146 MHz
- 1.25 m band : 222 ~ 225 MHz
- 70 cm band : 420 ~ 450 MHz or 430 ~ 440 MHz

CONTENTS

MODELS COVERED BY THIS MANUAL	
MARKET CODES	
NOTICE TO USER	
PRECAUTIONS	
THANK YOU	i
FEATURES	i
SUPPLIED ACCESSORIES	i
WRITING CONVENTIONS FOLLOWED	i
CONTENTS	ii

CHAPTER 1 PREPARATION

INSTALLING THE Li-ion BATTERY PACK	1
INSTALLING ALKALINE BATTERIES	1
INSTALLING THE ANTENNA	1
ATTACHING THE HAND STRAP	1
INSTALLING THE BELT CLIP	1
CHARGING THE Li-ion BATTERY PACK	2
CONNECTING TO A CIGARETTE LIGHTER SOCKET	2
CONNECTING TO A REGULATED POWER SUPPLY	2

CHAPTER 2 YOUR FIRST QSO

FIRST QSO	3
-----------------	---

CHAPTER 3 GETTING ACQUAINTED

KEYS AND CONTROLS	4
DISPLAY	5
BASIC OPERATION	
SWITCHING POWER ON/ OFF	6
ADJUSTING VOLUME	6
ADJUSTING SQUELCH	6
SELECTING A BAND	6
MULTI-SCROLL KEY	6
TRANSMITTING	7
Selecting Output Power	7
SELECTING A FREQUENCY	7
VFO mode	7
MHz mode	7
Direct Frequency Entry	7

CHAPTER 4 MENU SETUP

WHAT IS A MENU?	9
MENU ACCESS	9
SELECTING A MENU LANGUAGE	9
MENU FUNCTION LIST	9
ALPHABETICAL FUNCTION LIST	11

CHAPTER 5 OPERATING THROUGH REPEATERS

OFFSET PROGRAMMING FLOW	12
PROGRAMMING OFFSET	12
Selecting Offset Direction	12
Selecting Offset Frequency	12
Activating Tone Function	13
Selecting a Tone Frequency	13
AUTOMATIC REPEATER OFFSET	13
REVERSE FUNCTION	14
AUTOMATIC SIMPLEX CHECK (ASC)	14

TONE FREQ. ID SCAN	14
--------------------------	----

CHAPTER 6 MEMORY CHANNELS

SIMPLEX & REPEATER OR ODD-SPLIT MEMORY CHANNEL?	15
STORING SIMPLEX FREQUENCIES OR STANDARD REPEATER FREQUENCIES	15
STORING ODD-SPLIT REPEATER FREQUENCIES	15
RECALLING A MEMORY CHANNEL	16
Using the Tuning Control or ▲/▼ keys	16
Using a Numeric Keypad	16
CLEARING A MEMORY CHANNEL	16
MEMORY RECALL MODE	16
NAMING A MEMORY CHANNEL	17
MEMORY CHANNEL GROUPS	18
RECALLING A MEMORY CHANNEL USING MEMORY GROUP FUNCTION	18
ERASING MEMORY CHANNELS USING MEMORY GROUP DELETE FUNCTION	18
MEMORY CHANNEL TRANSFER	18
MEMORY → VFO TRANSFER	18
CHANNEL → CHANNEL TRANSFER	18
CALL CHANNEL	19
RECALLING THE CALL CHANNEL	19
REPROGRAMMING THE CALL CHANNEL	19
INFORMATION CHANNELS	20
RECALLING AN INFORMATION CHANNEL	20
REPROGRAMMING THE INFORMATION CHANNEL	20
CHANNEL DISPLAY	21

CHAPTER 7 SCAN

NORMAL SCAN	22
BAND SCAN	22
PROGRAM SCAN	23
Storing Program Scan Frequency Range	23
Performing the Program Scan	23
MHz SCAN	23
MEMORY SCAN	24
ALL-CHANNEL SCAN	24
GROUP SCAN	24
Memory Group Link	24
CALL SCAN	25
PRIORITY SCAN	25
PROGRAMMING PRIORITY CHANNELS	25
USING PRIORITY SCAN	25
INFORMATION CHANNEL SCAN	26
VISUAL SCAN	26
USING VISUAL SCAN (VFO)	26
USING VISUAL SCAN (MEMORY CHANNEL)	27
MEMORY CHANNEL LOCKOUT	27
SCAN RESUME METHOD	27

CHAPTER 8 SELECTIVE CALL

CTCSS and DCS	28
CTCSS	28
USING CTCSS	28

PREPARATION

INSTALLING THE Li-ion BATTERY PACK

Note: Because the battery pack is provided uncharged, you must charge the battery pack before using it with the transceiver. To charge the battery pack, refer to "CHARGING THE Li-ion BATTERY PACK" (page 2).

- 1 Position the two grooves on the edge and two hooks at the bottom of the battery pack over the corresponding guides on the back of the transceiver.

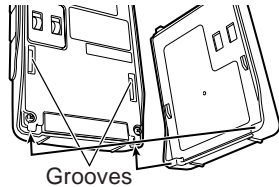

- 2 Slide the battery pack along the back of the transceiver until the release latch on the top of the transceiver locks the battery pack in place.

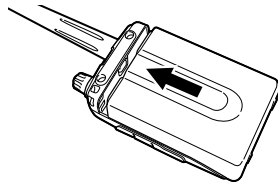

- 3 To remove the battery pack, push the release latch on top, then slide the battery pack down.

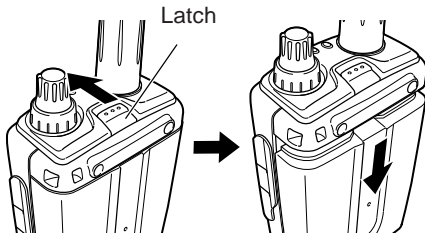

INSTALLING ALKALINE BATTERIES

- 1 To open the battery case (BT-13), push the locking tab in, then pull the cover back.

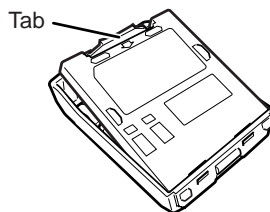

- 2 Insert (or remove) four AA (LR6) alkaline batteries.
 - Be sure to match the battery polarities with those marked in the bottom of the battery case.

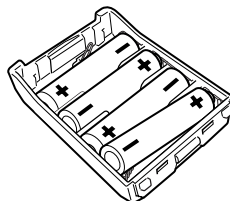

- 3 Align the two tabs on the battery case cover, then close the cover until the locking tabs click.

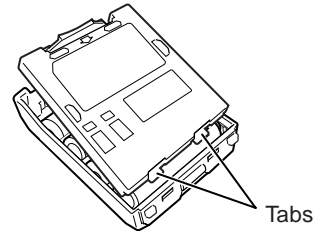

- 4 To install the battery case onto (or remove it from) the transceiver, follow steps 1 to 3 of "INSTALLING THE Li-ion BATTERY PACK" {above}.

Note: When you use the alkaline batteries, access Menu No. 30 (BATTERY), then select "ALKALINE". Otherwise, the battery remaining cannot be measured correctly (page 36).

INSTALLING THE ANTENNA

Hold the base of the supplied antenna, then screw the antenna into the connector on the top panel of the transceiver until secure.

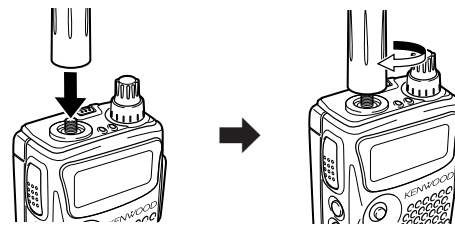

ATTACHING THE HAND STRAP

If desired, you can attach the supplied hand strap to the transceiver.

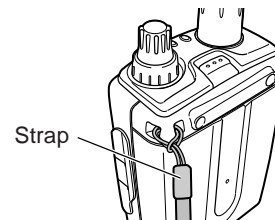

INSTALLING THE BELT CLIP

You can install the supplied belt clip to the transceiver tightening the 2 supplied screws.

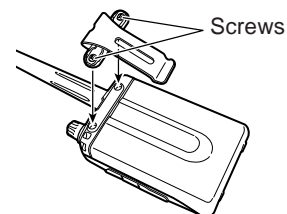

1 PREPARATION

CHARGING THE Li-ion BATTERY PACK

The Li-ion battery pack can be charged after it has been installed onto the transceiver. The battery pack is provided uncharged for safety purposes.

- 1 Confirm that the transceiver power is OFF.
 - While charging the battery pack, leave the transceiver power OFF.
- 2 Insert the charger plug into the **DC IN** jack of the transceiver.

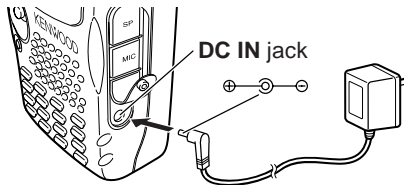

- 3 Plug the charger into an AC wall outlet.
 - Charging starts and 2 LEDs on the top panel lights orange.
- 4 It takes approximately 6.5 hours to charge an empty PB-42L Li-ion battery pack. When charging completes, the LEDs unlight; remove the charger plug from the transceiver **DC IN** jack.
- 5 Unplug the charger from the AC wall outlet.

Note:

- ◆ If you turn the transceiver ON and press **[F]**, **[LOW/BATT]** while charging the battery pack, "CHARGING" appears. "STANDBY" appears when the charging completes.
- ◆ The transceiver becomes warm while charging the battery pack.
- ◆ If the charger plug is plugged into the **DC IN** jack before the battery pack is attached, turn the transceiver ON and then OFF again to initiate the charging.

CAUTION

- ◆ Exceeding the specified charge period shortens the useful life of the Li-ion battery pack.
- ◆ The provided charger is designed to charge only the provided PB-42L Li-ion battery pack. Charging other models of battery packs may damage the charger and battery pack.
- ◆ Do not press **[PTT]** while charging.
- ◆ The battery pack must be kept in cool and dry place.
- ◆ Never leave the battery pack in the direct sun light.

CONNECTING TO A CIGARETTE LIGHTER SOCKET

To connect the transceiver to the cigarette lighter socket in your vehicle, use an optional PG-3J Cigarette Lighter cable.

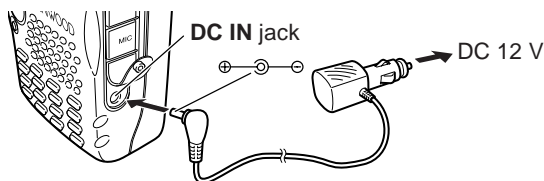

While the PG-3J is connected to the cigarette lighter plug, the transceiver automatically start charging the Li-ion battery pack (PB-42L). When you operate the transceiver, it charges the Li-ion battery pack in back

ground. If the transceiver is turned OFF, the 2 LEDs light orange while charging. When the charging completes, they turn OFF {above}.

CAUTION

To connect with an external 24 V power source via a DC-DC converter, only use the optional PG-3J Cigarette Lighter cable. Using the PG-2W DC cable in this situation may cause a fire.

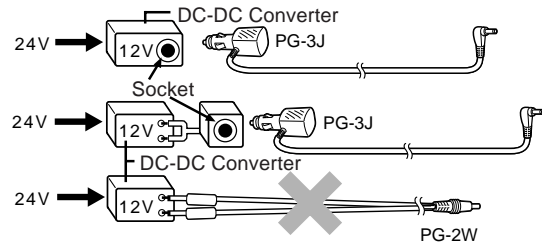

Note: If the input voltage exceeds approximately 16.5 V, warning beeps sound and "VOLTAGE ERROR" appears.

CONNECTING TO A REGULATED POWER SUPPLY

To connect the transceiver to an appropriate regulated power supply, use an optional PG-2W DC cable.

- 1 Confirm that the power of both the transceiver and the power supply are OFF.
- 2 Connect the optional PG-2W DC cable to the power supply; the red lead to the positive (+) terminal, and the black lead to the negative (-) terminal.

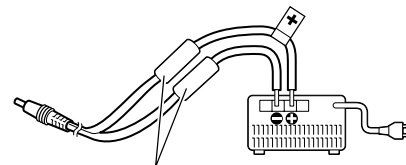

Fuses (4 A)

- 3 Connect the barrel plug on the DC cable to the **DC IN** jack of the transceiver.

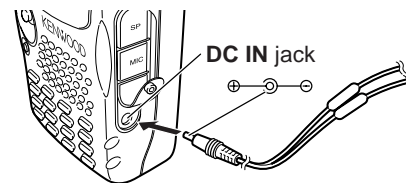

If the transceiver is turned OFF while a regulated power supply is connected with the **DC IN** jack, it automatically initiates charging the Li-ion battery pack (PB-42L) {above}.

Note:

- ◆ If the DC power supply voltage is below 12.0 V DC, you may not be able to charge the Li-ion battery pack (PB-42L).
- ◆ The supply voltage must be between 12.0 V and 16.0 V to prevent damaging the transceiver. If input voltage exceeds approximately 16.5 V, warning beeps sound and "VOLTAGE ERROR" appears. Remove the **DC IN** jack plug immediately.
- ◆ If the DC power supply voltage is above 14.5 V DC and "H" (High Power) is selected, "H" icon blinks and the output power is reduced to "L" level (Low Power) automatically {page 41}.

FIRST QSO

Are you ready to give your transceiver a quick try? Reading this page should get your voice on the air right away. The instructions below are intended only for a quick guide. If you encounter problems or there is something you would like to know more, read the detailed explanations given later in this manual.

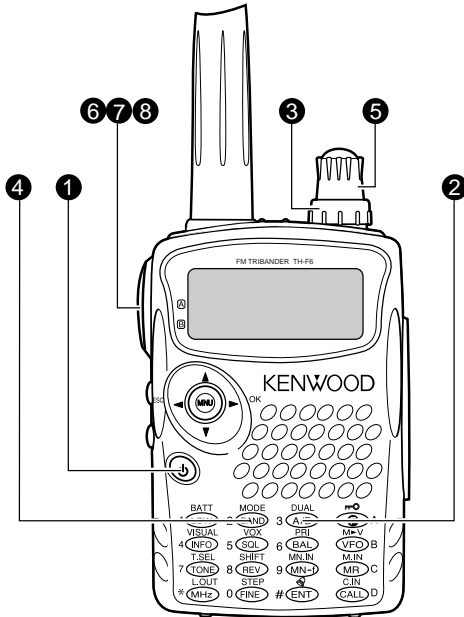

- 1 Press and hold [] (POWER) briefly to switch the transceiver power ON.
 - A high pitched double beep sounds and then “KENWOOD” and “HELLO !!” appear momentarily. The various indicators and 2 frequencies appear on the LCD.
 - The transceiver stores the parameters when it is turned OFF. It automatically recalls these parameters next time you turn the transceiver ON again.
- 2 Press [A/B] to select the frequency band on top.
 - Each time you press [A/B], the “▶” icon moves, indicating which frequency band is currently selected for operation.

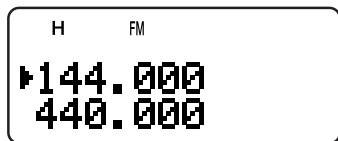

- 3 Turn the VOL control clockwise to the 11 o'clock position.

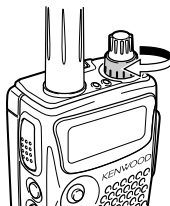

- 4 Press [BAND] until you select the amateur radio band you wish to operate.
- 5 Turn the Tuning control to select the receive frequency.

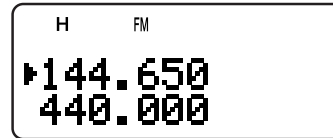

- You may further turn the VOL control to adjust the volume level of the signal.
- 6 To transmit, hold the transceiver approximately 5 cm (2 inches) from your mouth.
 - 7 Press and hold the PTT switch, then speak in your normal tone of voice.
 - 8 Release the PTT switch to receive.
 - 9 Repeat steps 6, 7 and 8 to continue communication.

GETTING ACQUAINTED

KEYS AND CONTROLS

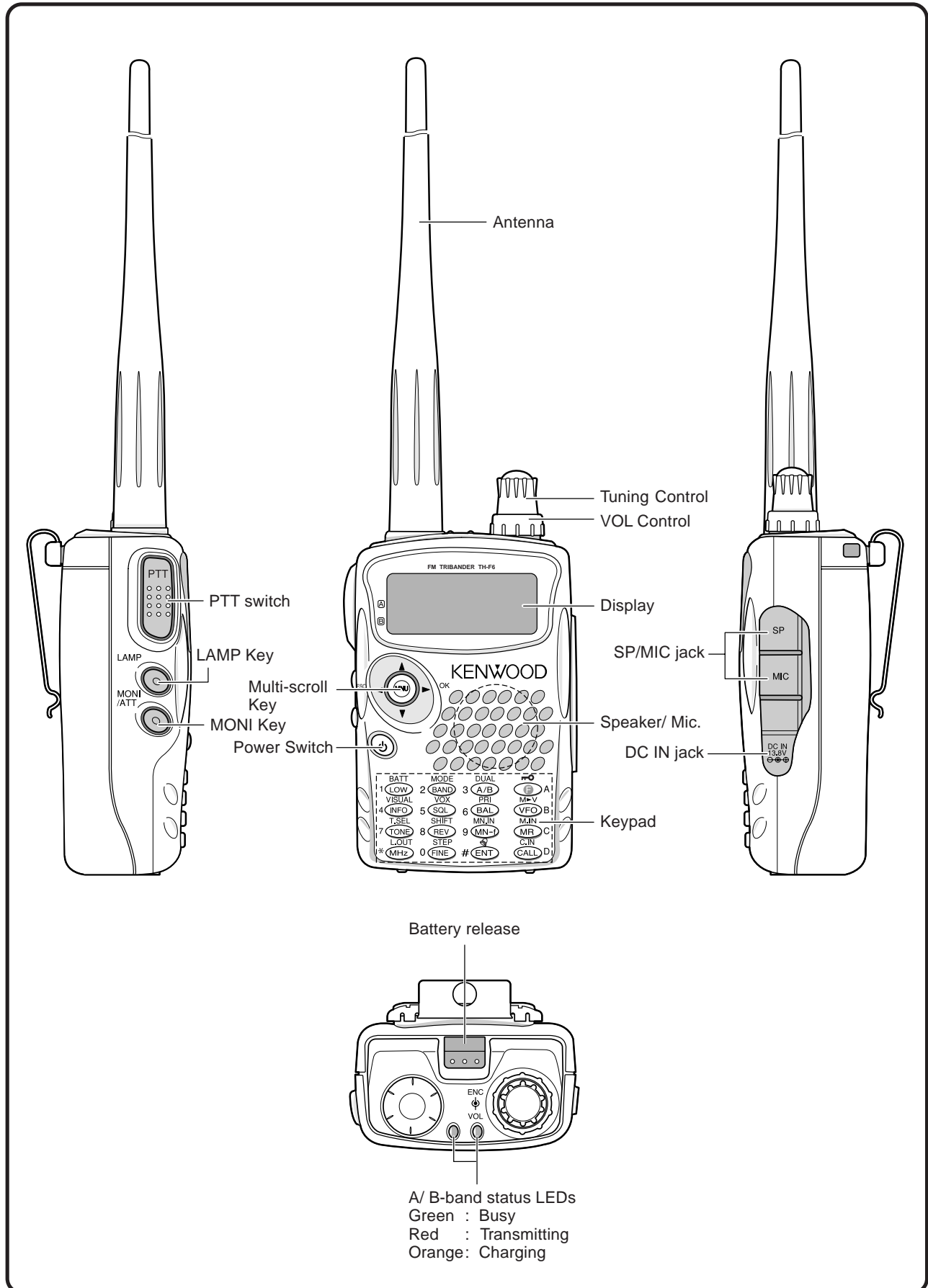

DISPLAY

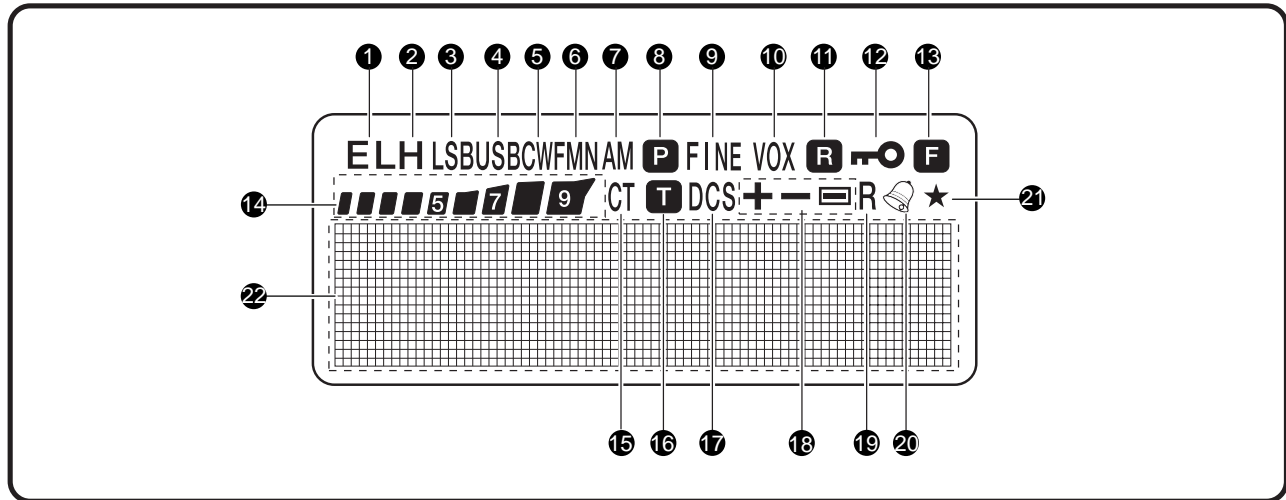
**1 EL**

Appears when the transmit output power is set to Low ("L") or Economic Low ("EL") {pages 7, 41}.

2 H

Appears when the transmit output power is set to High ("H") {pages 7, 41}.

3 LSB

Appears when lower side band (LSB) is selected for B-band {page 34}.

4 USB

Appears when upper side band (USB) is selected for B-band {page 34}.

5 CW

Appears when CW is selected for B-band {page 34}.

6 WFMN

"WFM" appears when wide FM mode is selected {page 34}. "FM" appears when normal FM mode is selected. "FMN" appears when narrow FM mode is selected {page 39}.

7 AM

"AM" appears when AM mode is selected {page 34}.

8 P

Appears when a Priority Scan is activated {page 25}.

9 FINE

Appears when a Fine Tuning function is activated {page 35}.

10 VOX

Appears when the VOX function is activated {page 41}.

11 R

Appears when the Automatic Simplex Check (ASC) is activated {page 14}.

12 Lock icon

Appears when the Lock function is ON {page 38}.

13 F

Appears when the function key is pressed.

14 S-meter and RF power meter

S-meter (RX) and relative RF power meter (TX).

15 CT

"CT" appears when the CTCSS function is activated {page 28}.

16 T

Appears when the Tone function is activated {page 13}.

17 DCS

Appears when the DCS function is activated {page 29}.

18 +/- and square icon

Appears when the repeater shift function is activated {page 12}.

19 R

Appears when the Reverse function is activated {page 14}.

20 Bell icon

Appears when the Tone Alert function is activated {page 40}.

21 Star icon

Appears when the displayed memory channel has been locked out {page 27}.

22 Dot-matrix display

76 x 16 dot-matrix display. It displays various information, such as the operating frequencies, menu settings, and etc.

3 GETTING ACQUAINTED

BASIC OPERATION

SWITCHING POWER ON/ OFF

- 1 Press [ϕ] (POWER) briefly to switch the transceiver power ON.
 - Upon power up, a high pitched double beep sounds, followed by the frequencies and other indicators.

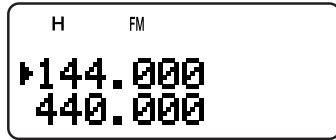

- 2 To switch the transceiver OFF, press [ϕ] (POWER) again.
 - When you turn the transceiver OFF, a low pitched double beep sounds.
 - The transceiver stores the parameters when it is turned OFF. It recalls these parameters next time you turn the transceiver ON again.

ADJUSTING VOLUME

Turn the **VOL** control clockwise to increase the audio output level and counterclockwise to decrease the output level.

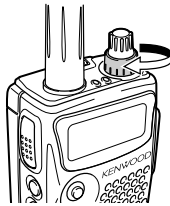

- If you are not receiving a signal, press and hold [MONI] to unmute the speaker, then adjust the **VOL** control to a comfortable audio output level.

ADJUSTING SQUELCH

The purpose of the Squelch is to mute the speaker when no signals are present. With the squelch level correctly set, you will hear sound only while actually receiving signals. The higher the selected squelch level, the stronger the signals must be, to receive. The appropriate squelch level depends on the ambient RF noise conditions. You can configure independent threshold squelch levels for the A-band and B-band.

- 1 Press [SQL].
 - The current squelch level appears.

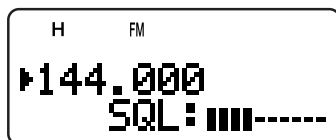

- 2 Turn the **Tuning** control or press [Δ] / [∇] to adjust the level.
 - Select the level at which the background noise is just eliminated when no signal is present.

- The higher the level, the stronger the signals must be, to receive.
- 6 different levels can be set
(- - - - - -: level 0 ~ || || || || ||: level 5).

- 3 Press [\blacktriangleright] or [MNU] to store the new settings or press [\blacktriangleleft] to cancel without changing the current setting.

Note: When operating in USB, LSB and CW modes, the squelch unmutes up to level 2.

SELECTING A BAND

By default, two frequencies are displayed on the LCD. The frequency on top is called the A-band. The bottom frequency is called the B-band.

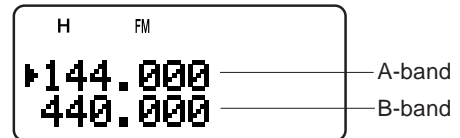

Press [A/B] to select the A-band or B-band for operation. Each time you press [A/B], the “ \blacktriangleright ” icon moves, indicating which band is currently selected for operation. Usually, select the A-band to operate the amateur band and select the B-band to receive the various broadcasting stations, such as AM, FM, TV (audio only) or another amateur band {page 33}.

MULTI-SCROLL KEY

This transceiver has a 4-way cursor key with a MENU (“MNU”) key in the center.

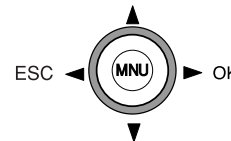

Δ / ∇ keys

The Δ / ∇ keys function in the same way as the **Tuning** control. These keys change the frequencies, memory channels, and other selections.

Note: You can use the **Tuning** control in place of the Δ / ∇ keys for most of the controls.

\blacktriangleright / OK key

Press to move to the next step or complete the setting in various modes, such as Menu mode, CTCSS frequency selection, and DCS code selection.

\blacktriangleleft / ESC key

Press to move back or cancel the entry in various modes, such as Menu mode, CTCSS frequency selection, and direct frequency entry.

MNU key

Press to enter the Menu mode.

In Menu mode, you can select the desired menu number by turning the **Tuning** control or pressing [Δ] / [∇]. It also functions as [OK] key.

TRANSMITTING

- To transmit, hold the transceiver approximately 5 cm (2 inches) from your mouth, then press and hold the **PTT** switch and speak into the microphone in your normal tone of voice.
 - The status LED on the top panel lights red and bar-graph meter appears.
 - If you press **[PTT]** while you are outside of the transmission coverage, a high pitched error beep sounds.

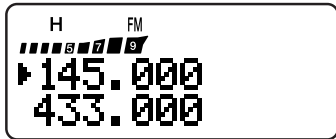

- When you finish speaking, release the **PTT** switch.

*Note: If you transmit continuously for more than 10 minutes, the internal time-out timer generates a warning beep and the transceiver stops transmitting. In this case, release the **PTT** switch and let the transceiver cool down for a while, then press the **PTT** switch again to resume transmitting {pages 40, 51}.*

Selecting Output Power

Selecting lower transmission power is the best way to reduce the battery consumption, if communication is still reliable. You can configure different power levels for transmission {page 41}.

Press **[LOW]**.

- Each time you press **[LOW]**, the indicator cycles between “H” (high), “L” (low), and “EL” (economic low).

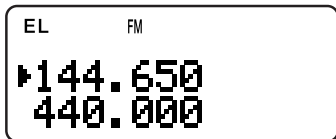

Note:

- You can store different output power setting for the A and B-band.
- When you change the output power, it is reflected to all available amateur bands for A or B-band.

SELECTING A FREQUENCY

VFO Mode

This is the basic mode for changing the operating frequency. Turn the **Tuning** control clockwise to increase the frequency. Turn the **Tuning** control counterclockwise to decrease the frequency. Or, press **[▲]/ [▼]** to change the frequency.

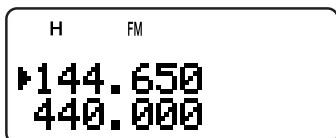

MHz Mode

If the desired operating frequency is far away from the current frequency, it is quicker to use the MHz tuning mode.

To adjust the MHz digit:

- Press **[MHz]**.
 - A MHz digit blinks.
- Turn the **Tuning** control or press **[▲]/ [▼]** to select the desired MHz digit.

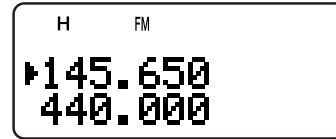

- After selecting the desired MHz digit, press **[MHz]** to exit the mode and return to normal VFO mode {above}.
- You may further adjust the frequency using the **Tuning** control or **[▲]/ [▼]**.

Note: MHz mode does not function in AM band.

Direct Frequency Entry

In addition to turn the **Tuning** control or press **[▲]/ [▼]**, there is another way of selecting the frequency. When the desired frequency is far away from the current frequency, you can directly enter a frequency from the numeric keypad.

- Press **[VFO]**.
 - You must be in the VFO mode to make the direct frequency entry.
- Press **[ENT]**.
 - “----” appears.

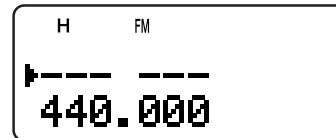

- Press the numeric keys (**[0]** to **[9]**) to enter your desired frequency. **[MHz]** can be used to complete the MHz digits entry.

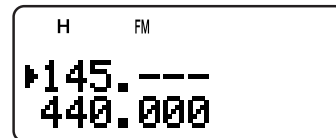

- Pressing **[ENT]** fills the remaining digits (the digits you did not enter) with 0 and completes the entry.
- To select 145.000 MHz for example, press **[1]**, **[4]**, **[5]** then press **[ENT]** to complete the entry.
- If you want to revise the MHz digits only, press **[VFO]** in place of **[ENT]**.

3 GETTING ACQUAINTED

Example 1 (100 MHz < f < 1000 MHz)

To enter 438.320 MHz:

Key in	Display
[ENT]	----
[4], [3], [8]	4 3 8. ---
[3], [2], [0]	4 3 8. 3 2 0

Note: You do not have to press **[MHz]** when you are entering 3-digit MHz number.

Example 2

To enter 439.000 MHz:

Key in	Display
[ENT]	----
[4], [3], [9]	4 3 9. ---
[ENT]	4 3 9. 0 0 0

Example 3

To revise 144.650 MHz to 145.650 MHz:

Key in	Display
	1 4 4. 6 5 0
[ENT]	----
[1], [4], [5]	1 4 5. ---
[VFO]	1 4 5. 6 5 0

Example 4 (f > 1000 MHz)

To enter 1250.500 MHz (B-band only):

Key in	Display
[ENT]	----
[1], [2], [5], [0]	12 5 0. ---
[5]	12 5 0. 5 --
[ENT]	12 5 0. 5 0 0

Example 5 (f < 100 MHz)

To enter 10.500 MHz (B-band only):

Key in	Display
[ENT]	----
[1], [0]	1 0 - ---
[MHz]	1 0. ---
[5]	1 0. 5 --
[ENT]	1 0. 5 0 0

Note: When pressing the last **[ENT]**, the Fine Tuning function is automatically activated for 10.5000 MHz.

Example 6

To enter 810 kHz (B-band only):

Key in	Display
[ENT]	----
[0]	0 - - - -
[MHz]	0. - - - -
[8], [1], [0]	0. 8 1 0

Note:

- ◆ If the entered frequency does not match the current frequency step size, the frequency is automatically rounded down to the next available frequency.
- ◆ When the desired frequency cannot be entered exactly, check whether the Fine Tuning function is ON or not (page 35), and then confirm the frequency step size (page 37).
- ◆ Some frequency ranges are blocked, due to government regulations. Refer to the specifications (pages 53, 54) for the TX/RX coverage.
- ◆ If you turn the **Tuning** control or press **[▲]**/**[▼]** while entering the frequency, the transceiver clears the entry and recovers the previous frequency and mode.

WHAT IS A MENU?

Many functions on this transceiver are selected or configured via a software-controlled Menu, rather than through the physical controls of the transceiver. Once familiar with the Menu system, you will appreciate the versatility it offers. You can customize the various timings, settings, and programming functions on this transceiver to meet your needs without using many controls and switches.

MENU ACCESS

- 1 Press **[MNU]**.
 - The Menu No. and setting appear on the display, along with a brief explanation of the Menu No.
- 2 Turn the **Tuning** control or press **[▲]/ [▼]** to select your desired Menu No.
 - As you change the Menu No., a brief explanation of each Menu No. appears.
- 3 Press **[▶]** or **[MNU]** to configure the parameter of the currently selected Menu No.

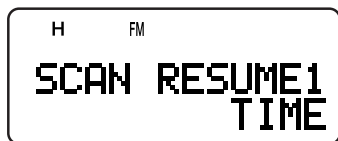

- 4 Turn the **Tuning** control or press **[▲]/ [▼]** to select your desired parameter.
- 5 Press **[▶]** or **[MNU]** to store the setting. Otherwise, press **[◀]** or **[PTT]** to cancel.

MENU FUNCTION LIST

On the Display	Menu No.	Function	Selections	Default	Ref. Page
SCAN RESUME	1	Scan resume method TIME: Time-Operated mode CARRIER: Carrier-Operated mode SEEK: Seek and stop mode	TIME/ CARRIER/ SEEK	TIME	27
M.GRP LINK	2	Memory Group Link configuration	0 1 2 3 4 5 6 7	No Links	24
MR METHOD	3	Memory Recall condition	ALL BANDS/ CURRENT BAND	ALL BANDS	16
PROG VFO	4	Programmable VFO frequency range (A-band only)	—	See Reference Page	39
AUTO OFFSET	5	Auto Repeater Offset function	ON/ OFF	ON	13
OFFSET	6	Repeater offset frequency	0.00 ~ 59.95 MHz in steps of 0.05 MHz	See Reference Page	12
TUNE ENABLE	7	Permit use of the Tuning control when the keys are locked	ON/ OFF	OFF	38
TX INHIBIT	8	Inhibit the transmission	ON/ OFF	OFF	40
SP/MIC JACK	9	Select the SP/MIC jack function	SP/MIC / TNC/ PC	SP/MIC	45 46

SELECTING A MENU LANGUAGE

You can select either English or Japanese (Katakana) for the menu description. To switch the language:

- 1 Press **[MNU]**.
- 2 Turn the **Tuning** control or press **[▲]/ [▼]** to select Menu No. 27.
- 3 Press **[▶]** or **[MNU]**.
- 4 Turn the **Tuning** control or press **[▲]/ [▼]** to select either "ENGLISH" or "JAPANESE".

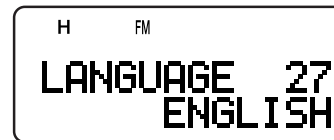

- 5 Press **[▶]** or **[MNU]** to store the setting. Otherwise, press **[◀]** or **[PTT]** to cancel.
 - When you select "JAPANESE" in step 3 and press **[▶]** or **[MNU]**, all Menu explanations are displayed in Japanese (Katakana). To return to English mode, repeat step 1, 2 and 3 {above} to access Menu No. 27, then select "ENGLISH". Press **[▶]** or **[MNU]** to display the Menu mode in English.

Note: The menu language selection does not affect any other modes, such as memory name {page 17} or DTMF name {page 31}.

4 MENU SETUP

On the Display	Menu No.	Function	Selections	Default	Ref. Page
DTMF STORE	10	Store DTMF numbers in DTMF memories	—	No Data	31
DTMF SPD	11	DTMF tone transmission speed	FAST/ SLOW	FAST	32
DTMF HOLD	12	Hold the transmission for 2 seconds between DTMF key entries	ON/ OFF	OFF	31
DTMF PAUSE	13	The pause duration while transmitting DTMF tones	100/ 250/ 500/ 750/ 1000/ 1500/ 2000 ms	500 ms	32
DTMF LOCK	14	Disable DTMF transmission with keys	ON/ OFF	OFF	32
PWR-ON MSG	15	Power-on message	8 characters	HELLO !!	39
CONTRAST	16	LCD display contrast 1: minimum ~ 16: maximum	1 ~ 16	8	37
BAT SAVER	17	Battery saver receiver shut-off period	OFF/ 0.2/ 0.4/ 0.6/ 0.8/ 1.0/ 2.0/ 3.0/ 4.0/ 5.0 sec.	1.0 sec.	37
APO	18	Automatic Power Off function	OFF/ 30/ 60 min.	30 min.	36
KEY BEEP	19	Beep function	ON/ OFF	ON	37
VOXonBUSY	20	Allow VOX transmission when the receiver is busy	ON/ OFF	OFF	42
VOX GAIN	21	Set the VOX gain sensitivity 0: least sensitive ~ 9: most sensitive	0 ~ 9	4	41
VOX DELAY	22	Adjust the VOX delay time	250/ 500/ 750/ 1000/ 1500/ 2000/ 3000 ms	500 ms	41
CALL KEY	23	Select a function for the CALL key	CALL/ 1750 Hz	CALL (TH-F6A) 1750 Hz (TH-F7E)	19
1750 HOLD	24	Hold the TX status when a 1750 Hz tone is transmitted	ON/ OFF	OFF	13
BEAT SHIFT	25	Shift the internal CPU clock frequency	ON/ OFF	OFF	37
BAR ANT	26	Enable an internal bar antenna below 10.1 MHz	ENABLED/ DISABLED	ENABLED	34
LANGUAGE	27	Select the menu language	ENGLISH/ JAPANESE	ENGLISH	9
PACKET	28	Select an external TNC packet speed	1200/ 9600 bps	1200 bps	45
FM NARROW	29	FM narrow band operation	ON/ OFF	OFF	39
BATTERY	30	Select a battery type	LITHIUM/ ALKALINE	LITHIUM	36
RESET?	31	Select a reset mode	NO/ VFO RESET/ MENU RESET/ FULL RESET	NO	50

ALPHABETICAL FUNCTION LIST

On the Display	Menu No.	Selections	Default	Ref. Page
APO	18	OFF/ 30/ 60 minutes	30 min.	36
AUTO OFFSET	5	ON/ OFF	ON	13
BAR ANT	26	ENABLED/ DISABLED	ENABLED	34
BATTERY	30	LITHIUM/ ALKALINE	LITHIUM	36
BAT SAVER	17	OFF/ 0.2/ 0.4/ 0.6/ 0.8/ 1.0/ 2.0/ 3.0/ 4.0/ 5.0 sec.	1.0 sec.	37
BEAT SHIFT	25	ON/ OFF	OFF	37
CALL KEY	23	CALL/ 1750 Hz	CALL (TH-F7E)/ 1750 Hz (TH-F6A)	19
CONTRAST	16	1 ~ 16	8	37
DTMF HOLD	12	ON/ OFF	OFF	31
DTMF LOCK	14	ON/ OFF	OFF	32
DTMF PAUSE	13	100/ 250/ 500/ 750/ 1000/ 1500/ 2000 ms	500 ms	32
DTMF SPD	11	FAST/ SLOW	FAST	32
DTMF STORE	10	—	No Data	31
FM NARROW	29	ON/ OFF	OFF	39
KEY BEEP	19	ON/ OFF	ON	37
LANGUAGE	27	ENGLISH/ JAPANESE	ENGLISH	9
MR METHOD	3	ALL BANDS/ CURRENT BAND	ALL BANDS	16
M.GRP LINK	2	0 1 2 3 4 5 6 7	No Links	24
OFFSET	6	0.00 ~ 59.95 MHz in steps of 0.05 MHz	See Reference Page	12
PACKET	28	1200/ 9600 bps	1200 bps	45
PROG VFO	4	—	—	39
PWR-ON MSG	15	8 characters	HELLO !!	39
RESET?	31	NO/ VFO RESET/ MENU RESET/ FULL RESET	NO	50
SCAN RESUME	1	TIME/ CARRIER/ SEEK	TIME	27
SP/MIC JACK	9	SP/MIC / TNC/ PC	SP/MIC	45, 46
TUNE ENABLE	7	ON/ OFF	OFF	38
TX INHIBIT	8	ON/ OFF	OFF	40
VOX DELAY	22	250/ 500/ 750/ 1000/ 1500/ 2000/ 3000 ms	500 ms	41
VOX GAIN	21	0 ~ 9	4	41
VOXonBUSY	20	ON/ OFF	OFF	42
1750 HOLD	24	ON/ OFF	OFF	13

OPERATING THROUGH REPEATERS

Repeaters, which are often installed and maintained by radio clubs, are usually located on mountain tops or other elevated locations. Generally they operate at higher ERP (Effective Radiated Power) than a typical station. This combination of elevation and high ERP allows communications over much greater distances than communications without using repeaters.

Most repeaters use a receive and transmit frequency pair with a standard or non-standard offset (odd-split). In addition, some repeaters must receive a tone from the transceiver to allow it to access. For details, consult your local repeater reference.

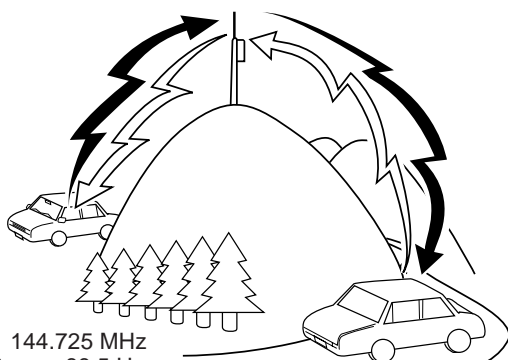

TX: 144.725 MHz
TX tone: 88.5 Hz
RX: 145.325 MHz

TX: 144.725 MHz
TX tone: 88.5 Hz
RX: 145.325 MHz

OFFSET PROGRAMMING FLOW

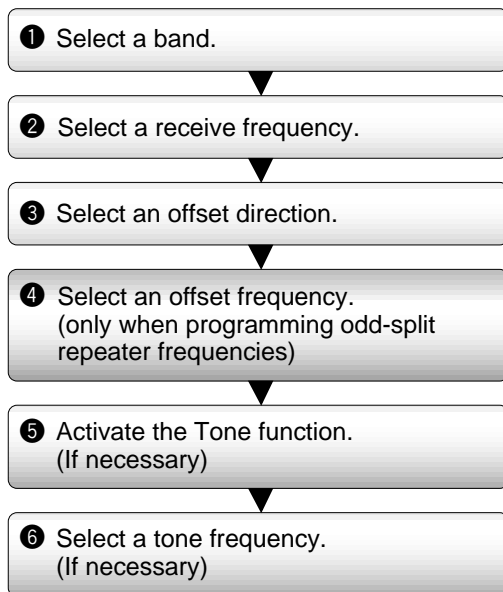

If you store the above data in a memory channel, you need not reprogram every time. See “MEMORY CHANNELS” {page 15}.

PROGRAMMING OFFSET

First select an amateur radio repeater downlink frequency on the A-band or B-band as described in “SELECTING A FREQUENCY” {page 7}.

■ Selecting Offset Direction

Select whether the transmit frequency will be higher (+) or lower (–) than the receive frequency.

Press **[F]**, **[REV]** to select the offset direction.

- “+” or “–” appears, indicating which offset direction is selected.

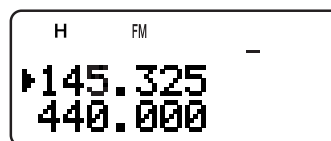

- To program –7.6 MHz offset on the TH-F7E (430 MHz only), repeatedly press **[F]**, **[REV]** until “=” appears.

If the offset transmit frequency falls outside the allowable range, transmitting is inhibited. In this case, adjust the receive frequency so that the transmit frequency is within the band limits.

Note: While using an odd-split memory channel or transmitting, you cannot change the offset direction.

■ Selecting Offset Frequency

To access a repeater which requires an odd-split frequency pair, change the offset frequency from the default which is used by most repeaters. The default offset frequency on the 2 m band is 600 kHz (all models); the default on the 70 cm band is 5.0 MHz (TH-F6A) or 1.6 MHz (TH-F7E); the default on the 1.25 m band is 1.6 MHz (TH-F6A).

- 1 Press **[BAND]** to select an amateur radio band you want to change the offset frequency.
- 2 Press **[MNU]**.
- 3 Turn the **Tuning** control or press **[▲]**/**[▼]** to select Menu No. 6 (OFFSET).



- 4 Press **[▶]** or **[MNU]**.
- 5 Turn the **Tuning** control or press **[▲]**/**[▼]** to select the appropriate offset frequency.
 - The selectable range is from 0.00 MHz to 59.95 MHz in steps of 50 kHz.
- 6 Press **[▶]** or **[MNU]** to store the setting. Otherwise, press **[PTT]** to cancel.

TH-F7E only: If you have selected “=” for the offset direction, you cannot change the default (–7.6 MHz) offset frequency.

Note: After changing the offset frequency, the new offset frequency will also be used by Automatic Repeater Offset.

■ **Activating Tone Function**

Press **[TONE]** to switch the Tone function ON (or OFF).

- “**T**” appears when the Tone function is ON.

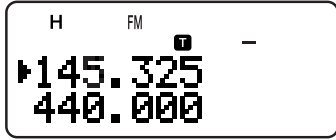

Note: You cannot use the Tone and CTCSS/ DCS functions at the same time. Switching the Tone function ON after activating the CTCSS/ DCS deactivates the CTCSS/ DCS function.

TH-F7E only: When you access repeaters that require 1750 Hz tones, you need not activate the Tone function. Press **[CALL]** without pressing the PTT switch to transmit a 1750 Hz tone (default setting).

■ **Selecting a Tone Frequency**

- 1 While the Tone function is ON, press **[F]**, **[TONE]**.
- 2 Turn the **Tuning** control or press **[▲]/ [▼]** to select the desired tone frequency.



- 3 Press **[▶]** or **[MNU]** to complete the setting. Otherwise, press **[PTT]** to cancel.

Available Tone Frequencies

No.	Freq. (Hz)	No.	Freq. (Hz)	No.	Freq. (Hz)	No.	Freq. (Hz)
01	67.0	12	97.4	23	141.3	34	206.5
02	69.3	13	100.0	24	146.2	35	210.7
03	71.9	14	103.5	25	151.4	36	218.1
04	74.4	15	107.2	26	156.7	37	225.7
05	77.0	16	110.9	27	162.2	38	229.1
06	79.7	17	114.8	28	167.9	39	233.6
07	82.5	18	118.8	29	173.8	40	241.8
08	85.4	19	123.0	30	179.9	41	250.3
09	88.5	20	127.3	31	186.2	42	254.1
10	91.5	21	131.8	32	192.8		
11	94.8	22	136.5	33	203.5		

Note: 42 different tones are available for the transceiver. These 42 tones includes 37 EIA standard tones and 5 non-standard tones.

TH-F7E only:

- ◆ To transmit a 1750 Hz tone, simply press **[CALL]** without pressing the PTT switch (default setting). Release **[CALL]** to quit transmitting. You can also make the transceiver remain in the transmit mode for 2 seconds after releasing **[CALL]**; a 1750 Hz tone is not continuously transmitted. Access Menu No. 24 (1750 HOLD) and select “ON”.
- ◆ If you desire to assign **[CALL]** for recalling the Call channel in place of transmitting the 1750 Hz tone, access Menu No. 23 (CALL KEY) and select “CALL”.

AUTOMATIC REPEATER OFFSET

This function automatically selects an offset direction, according to the frequency that you select on the 2 m and 1.25 m (TH-F6A only) bands. The transceiver is programmed for offset direction as shown below. To obtain an up-to-date band plan for repeater offset direction, contact your national Amateur Radio association.

TH-F6A (U.S.A. and Canada)

This complies with the standard ARRL band plan.

144.0	145.5	146.4	147.0	147.6
145.1	146.0	146.6	147.4	148.0 MHz

S	-	S	+	S	-	+	S	-
---	---	---	---	---	---	---	---	---

S: Simplex

222.0	223.920	225.0 MHz
-------	---------	-----------

S	-
---	---

S: Simplex

TH-F7E (Europe/ Others)

144.0	145.6	145.8	146.0 MHz
-------	-------	-------	-----------

S	-	S
---	---	---

S: Simplex

Note: Automatic Repeater Offset does not function when Reverse is ON. However, pressing **[REV]** after Automatic Repeater Offset has selected an offset (split) status, exchanges the receive and transmit frequencies.

- 1 Press **[MNU]**.
- 2 Turn the **Tuning** control or press **[▲]/ [▼]** to select Menu No. 5 (AUTO OFFSET).
- 3 Press **[▶]** or **[MNU]**.
- 4 Turn the **Tuning** control or press **[▲]/ [▼]** switch the function ON or OFF.

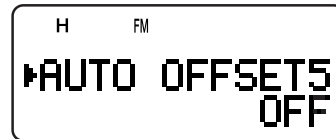

- 5 Press **[▶]** or **[MNU]** to store the setting. Otherwise, press **[PTT]** to cancel.

Note: If you select the frequency within the amateur radio band on the B-band, the Automatic Repeater Offset function is also activated in any modes.

5 OPERATING THROUGH REPEATERS

REVERSE FUNCTION

The reverse function exchanges a separate receive and transmit frequency. So, while using a repeater, you can manually check the strength of a signal that you receive directly from the other station. If the station's signal is strong, both stations should move to a simplex frequency and free up the repeater.

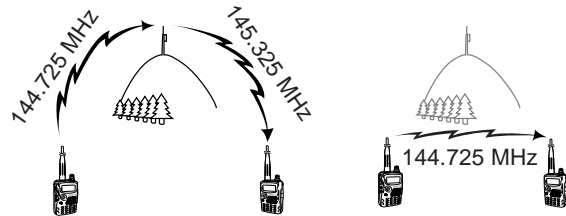

TX: 144.725 MHz TX: 144.725 MHz TX: 144.725 MHz TX: 145.325 MHz
RX: 145.325 MHz RX: 145.325 MHz RX: 145.325 MHz RX: 144.725 MHz

To swap the transmit and receive frequencies:

Press **[REV]** to switch the Reverse function ON (or OFF).

- “R” appears when the function is ON.

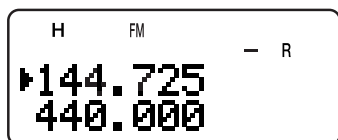

Note: You can turn the Reverse function ON when you are operating in Simplex mode. However, it does not change the TX/RX frequency.

AUTOMATIC SIMPLEX CHECK (ASC)

While using a repeater, the ASC function periodically checks the strength of a signal that you are receiving directly from the other station. If the station's signal is strong enough to allow direct contact without a repeater, “**R**” indicator on the display starts blinking.

Press **[REV]** (1 s) to switch the function ON.

- “**R**” appears when the function is ON.

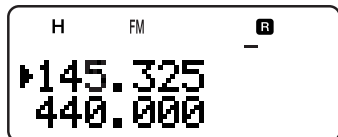

- While direct contact is possible, “**R**” blinks.
- To quit the function, press **[REV]**.

Note:

- ◆ Pressing the **PTT** switch causes “**R**” icon to quit blinking.
- ◆ ASC can be activated while operating in Simplex mode. However, it does not change the TX/RX frequencies.
- ◆ ASC does not function while scanning.
- ◆ Activating ASC while using Reverse switches Reverse OFF.
- ◆ If you recall a memory channel or the Call channel that contains a Reverse ON status, ASC is switched OFF.
- ◆ ASC causes received audio to be momentarily intermitted every 3 seconds.
- ◆ ASC does not function when the band is not selected for operation.

TONE FREQ. ID SCAN

This function scans through all tone frequencies to identify the incoming tone frequency on a received signal. You may use the function to find which tone frequency is required by accessing your local repeater.

- 1 While the Tone function is ON, press **[F]**, **[TONE]** (1 s) to start the Tone Freq. ID scan.
 - When the transceiver receives the signal, the scan starts.

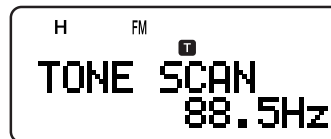

- To reverse the scan direction, turn the **Tuning** control or press **[▲]/[▼]**.
 - To quit the function, press **[PTT]** or **[◀]**.
 - When the tone frequency is identified, a beep sounds and the identified frequency appears.
- 2 Press **[▶]** to program the identified frequency in place of the current tone frequency.
 - Press **[◀]** if you do not want to program the identified frequency.
 - Press **[▲]/[▼]** while the identified frequency is blinking, to resume scanning.

Note: Some repeaters do not re-transmit the access tone in the downlink signal. In this case, check the other station's uplink signal to detect the repeater access tone.

MEMORY CHANNELS

In memory channels, you can store frequencies and related data that you often use. Then you need not reprogram those data every time. You can quickly recall a programmed channel through simple operation. A total of 400 memory channels are available for storing the frequencies, modes and other operating conditions of the A and B-bands.

SIMPLEX & REPEATER OR ODD-SPLIT MEMORY CHANNEL?

You can use each memory channel as a simplex & repeater channel or an odd-split channel. Store only one frequency to use as a simplex & repeater channel or two separate frequencies to use as an odd-split channel. Select either application for each channel depending on the operations you have in mind.

Simplex & repeater channels allow:

- Simplex frequency operation
- Repeater operation with a standard offset (if an offset direction is stored)

Odd-split channels allow:

- Repeater operation with a non-standard offset

Note: Not only can you store data in memory channels, but you can also overwrite existing data with new data.

The data listed below can be stored in each memory channel:

Parameter	Simplex & Repeater	Odd-Split
Receive frequency	Yes	Yes
Transmit frequency		Yes
Tone frequency	Yes	Yes
Tone ON	Yes	Yes
CTCSS frequency	Yes	Yes
CTCSS ON	Yes	Yes
DCS code	Yes	Yes
DCS ON	Yes	Yes
Offset direction	Yes	N/A
Offset frequency	Yes	N/A
Reverse ON	Yes	N/A
Frequency step size	Yes	Yes
Memory channel lockout	Yes	Yes
Memory channel name	Yes	Yes
FINE tuning ON	Yes	Yes
Mode selection	Yes	Yes

Yes: Can be stored in memory.

N/A: Cannot be stored in memory.

Note: The transmit frequency must be on the same band as the receive frequency band (Odd-split channel).

STORING SIMPLEX FREQUENCIES OR STANDARD REPEATER FREQUENCIES

- 1 Press **[VFO]**.
- 2 Turn the **Tuning** control or press **[▲]/ [▼]** to select your desired frequency in the amateur radio bands.
 - You can also directly enter desired frequency using the keypad {page 7}.
- 3 If storing a standard repeater frequency, select the following data:
 - Offset direction {page 12}
 - Tone function, if necessary {page 13}
 - CTCSS/ DCS function, if necessary {pages 28, 29}

If storing a simplex frequency, you may select other related data (CTCSS or DCS settings, etc.).

- 4 Press **[F]**.

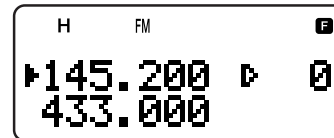

- A memory channel number appears and blinks.
- “▶” indicates the current channel is empty; “◀” appears if the channel contains data.
- Memory channel number L0/U0 ~ L9/U9 {page 23}, I-0 ~ I-9 {page 20}, and Pr1 and Pr2 {page 25} are reserved for other functions.

- 5 Turn the **Tuning** control or press **[▲]/ [▼]** to select the memory channel in which you want to store the data.
- 6 Press **[MR]** (▶) or **[MNU]** to store the data to the channel.

STORING ODD-SPLIT REPEATER FREQUENCIES

Some repeaters use a receive and transmit frequency pair with a non-standard offset. If you store two separate frequencies in a memory channel, you can operate on those repeaters without programming the offset frequency and direction.

- 1 Store the desired receive frequency and related data by the procedure given for simplex or standard repeater frequencies {above}.
- 2 Turn the **Tuning** control or press **[▲]/ [▼]** to select the desired transmit frequency.
- 3 Press **[F]**.
- 4 Turn the **Tuning** control or press **[▲]/ [▼]** to select the memory channel you programmed in step 1.
- 5 Press **[PTT]+[MR]** ([PTT]+▶) or **[PTT]+[MNU]**.
 - The transmit frequency is stored in the memory channel.

Note:

- ◆ When you recall an odd-split memory channel, “+” and “-” appear on the display. To confirm the transmit frequency, press **[REV]**.
- ◆ When you revise only the transmission frequency for the odd-split channel, the frequency step size must be the same as the original odd-split channel memory data.

6 MEMORY CHANNELS

RECALLING A MEMORY CHANNEL

There are 2 ways of recalling the desired memory channel.

■ Using the Tuning Control or ▲/▼ Keys

- 1 Press **[MR]** to enter Memory Recall mode.
 - The memory channel used last is recalled.

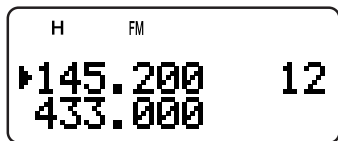

- 2 Turn the **Tuning** control or press **[▲]/[▼]** to select your desired memory channel.
 - You cannot recall an empty memory channel.
 - To restore VFO mode, press **[VFO]**.

Note: If the "CURRENT BAND" is selected for Menu No. 3 (MR METHOD), only memory channels that have the same band data can be recalled (below).

■ Using a Numeric Keypad

You can also recall a memory channel by entering a desired memory channel number with the keypad.

- 1 Press **[MR]** to enter Memory Recall mode.
- 2 Press **[ENT]**, then enter the channel number using 3 digits.
 - For example, to recall channel 12, press **[ENT]**, **[0]**, **[1]**, **[2]**.
 - You can shorten the entry for memory channels that are less than 100 by pressing **[ENT]** after entering the channel number. For example, to recall memory channel 9, press **[ENT]**, **[9]**, **[ENT]**.

Note:

- ◆ You cannot recall an empty memory channel. An error beep sounds.
- ◆ You cannot recall the Program Scan memory channels (L0/U0 ~ L9/U9), Priority channels (Pr1 and Pr2), and Information Channels (I-0 ~ I-9), using the numeric keypad.
- ◆ When you recall an odd-split memory channel, "+" and "-" appear on the display. Press **[REV]** to display the transmit frequency.
- ◆ After recalling a memory channel, you may modify data such as Tone or CTCSS. These settings, however, are cleared once you select another channel or the VFO mode. To permanently store the data, overwrite the channel contents (page 15).

CLEARING A MEMORY CHANNEL

To clear an individual memory channel:

- 1 Recall the memory channel you want to erase.
- 2 Press and hold **[ϕ]** (POWER) to switch the transceiver OFF.
- 3 Press **[MR]+[ϕ]** (POWER).
 - An erase confirmation message appears.



- 4 Press **[MR]** (**[▶]**) or **[MNU]** to erase the channel data.
 - The contents of the memory channel are erased.
 - To quit clearing the memory channel, press any key other than **[MR]**, **[▶]** and **[MNU]**.

Note:

- ◆ If you clear the information channel data, the data will be set to the factory default values.
- ◆ You can also clear the Priority channel data and L0/U0 ~ L9/U9 data.
- ◆ To clear all memory channels contents, perform the Full Reset (page 50).

MEMORY RECALL MODE

Since the transceiver has more than 400 memory channels, it sometimes takes time to search for your desired memory channel. By default, the transceiver can recall all memory channels when **[MR]** is pressed, regardless of the current operating band. However, you can configure the transceiver to recall only the memory channels that have the same band information. For example, when you operate on the 2 m band in VFO mode, pressing **[MR]** recalls only the memory channels that have 2 m band information. To change the memory recall mode:

- 1 Press **[MNU]**.
- 2 Turn the **Tuning** control or press **[▲]/[▼]** to select Menu No. 3 (MR METHOD).
- 3 Press **[▶]** or **[MNU]**.
- 4 Turn the **Tuning** control or press **[▲]/[▼]** to select "CURRENT BAND".
- 5 Press **[▶]** or **[MNU]** to store the setting. Otherwise, press **[◀]** or **[PTT]** to cancel.

When you press **[MR]** in VFO mode, only memory channels that have the same band data are recalled. To return to the default memory recall mode, repeat step 1 to 5 {above} and select "ALL BANDS" in step 4.

Note:

- ◆ All Information Channels are recalled regardless of Memory Recall mode selection.
- ◆ Memory Recall mode selection does not change the Memory Group scan channels (page 24).

NAMING A MEMORY CHANNEL

You can name memory channels using up to 8 alphanumeric characters. When you recall a named memory channel, its name appears on the display in place of the stored frequency. Names can be call signs, repeater names, cities, names of people, etc.

- 1 Press **[MR]** to recall your desired memory channel.
- 2 Press **[F]**, **[MN<->f]** to enter memory name input mode.
 - The entry cursor appears.



- 3 Turn the **Tuning** control or press **[▲]/[▼]** to select the first character.
 - You can enter alphanumeric characters plus special ASCII characters. Refer to the following table for the available characters.
 - Press **[MONI]** to delete the character at the cursor position.
 - You can also use the numeric keypad to enter a character (Special ASCII characters are not available). For example, each press of **[2]** switches entry as a, b, c, 2, A, B, C and then back to a.
 - While pressing and holding **[LAMP]**, turn the **Tuning** control to jump to the first character of each ASCII character group.
- 4 Press **[▶]**.
 - The cursor moves to the next digit.
- 5 Repeat steps 3 and 4 to enter up to 8 digits.
 - Pressing **[▶]** after selecting the 8th digit completes the programming.
 - To complete programming before entering less than 8 digits, press **[MNU]** or press **[▶]** twice.
 - Press **[◀]** to move the cursor back.
 - Press **[PTT]** (**[F]**, **[VFO]**, **[MR]**, or **[CALL]**) to cancel the entry.

After storing a memory name, pressing **[MN<->f]** switches the display between the memory name and the frequency.

Note:

- ◆ You can also name the DTMF memory channels (page 31) and Information Channels (page 20) but you cannot name the Call channel (page 19).
- ◆ You cannot assign a memory name to a channel that does not contain data.
- ◆ You can overwrite stored names by repeating steps 1 to 5.
- ◆ The stored name is erased when you clear the memory channel data.

Available Characters Using the Tuning Control

Available Characters									
A	B	C	D	E	F	G	H	I	J
K	L	M	N	O	P	Q	R	S	T
U	V	W	X	Y	Z	[]	^	_
`	a	b	c	d	e	f	g	h	i
j	k	l	m	n	o	p	q	r	s
t	u	v	w	x	y	z	{		}
~	\	SP	!	"	#	\$	%	&	'
()	*	+	,	-	.	/	0	1
2	3	4	5	6	7	8	9	:	;
<	=	>	?	@					
Additional Characters for the TH-F7E									
À	Á	Â	Ã	Ä	Å	Æ	Ç	È	É
Ê	Ë	Ì	Í	Î	Ï	Ð	Ñ	Ò	Ó
Ô	Õ	Ö	Š	Ø	Ù	Ú	Û	Ü	Ý
Š	ß	Œ	à	á	â	ã	ä	å	æ
ç	è	é	ê	ë	ì	í	î	ï	ð
ñ	ò	ó	ô	õ	ö	œ	ø	ù	ú
û	ü	ý	ÿ	ÿ					

Available Characters Using the Numeric Keypad

DTMF Key	Available Characters							
1	q	z	1	Q	Z			
2	a	b	c	2	A	B	C	
3	d	e	f	3	D	E	F	
4	g	h	i	4	G	H	I	
5	j	k	l	5	J	K	L	
6	m	n	o	6	M	N	O	
7	p	r	s	7	P	R	S	
8	t	u	v	8	T	U	V	
9	w	x	y	9	W	X	Y	
0	space	0						
#	?	!	'	.	,	-	/	
	&	#	()	<	>	;	
	:	"	@					

6 MEMORY CHANNELS

MEMORY CHANNEL GROUPS

400 memory channels have been divided into 8 groups of 50. Group 0 contains memory channel numbers 0 ~ 49, group 1 is 50 ~ 99, group 2 is 100 ~ 149, and so on. You can categorize each group to store similar data, same frequency bands or same modes for ease of use.

Group #	Memory Channel	Group #	Memory Channel
Group 0	0 ~ 49	Group 4	200 ~ 249
Group 1	50 ~ 99	Group 5	250 ~ 299
Group 2	100 ~ 149	Group 6	300 ~ 349
Group 3	150 ~ 199	Group 7	350 ~ 399

RECALLING A MEMORY CHANNEL USING MEMORY GROUP FUNCTION

It is sometimes a tedious endeavor to scroll through 400 memory channels sequentially. However, using a Group memory recall function, you can access your desired memory channel numbers more quickly.

- 1 Press **[MR]** to enter Memory Recall mode.
- 2 While pressing and holding **[LAMP]**, turn the **Tuning** control to select a group.
 - Each click of the **Tuning** control, the lowest memory channel number of each group is recalled. For example, if you have the following memory channels that contain data:

Group #	Memory Channels that Contain Data					
Group 0	0	2	10	15	30	45
Group 1	50	61	65	78	98	
Group 2	103	111	123			
Group 3	152	166				
Group 4						
Group 5	260	280				
Group 6	305	322	333	345		
Group 7	399					

Memory channels 0, 50, 103, 152, 260, 305, 399, and then 0 are recalled sequentially while pressing and holding **[LAMP]**.

- 3 Release **[LAMP]** and turn the **Tuning** control to select the desired memory channels within the selected group.

Note: If you have configured Menu No. 3 (MR METHOD) as "CURRENT BAND" (page 16), only memory channels that have the same frequency band data are recalled.

ERASING MEMORY CHANNELS USING MEMORY GROUP DELETE FUNCTION

Instead of erasing each unnecessary channel one by one, you can erase an entire group of memory channels at once. For example, if you erase group 2 memory channels, all the data in memory channels 100 ~ 149 are erased.

- 1 Press **[MR]**.
 - Turn the **Tuning** control or press **[▲]/[▼]** to select a memory channel in the group you want to erase (for example, memory channel No. 111, in Group 2).
- 2 Press **[ϕ]** (POWER) to turn the transceiver OFF.
- 3 Press **[MHz]+[ϕ]** (POWER).
 - An erase confirmation message appears.



- 4 Press **[MR]** (**[▶]**) or **[MNU]** to proceed. Otherwise, press any other key to cancel the erase.

MEMORY CHANNEL TRANSFER MEMORY → VFO TRANSFER

After retrieving frequencies and associated data from Memory Recall mode, you can copy the data to the VFO. This function is useful, for example, when the frequency you want to monitor is near the frequency stored in a memory channel.

- 1 Press **[MR]**, then turn the **Tuning** control to recall a desired memory channel.
- 2 Press **[F]**, **[VFO]** to copy the memory channel data to the VFO.

Note:

- ◆ To copy an odd-split channel data (page 15), turn the Reverse function ON (page 14) before performing the transfer.
- ◆ You can also transfer the Program Scan memory channels (L0/U0 ~ L9/U9), Priority Channels (Pr1 and Pr2), and Information Channels (I-0 ~ I-9) to the VFO.

CHANNEL → CHANNEL TRANSFER

You can also copy channel information from one memory channel to another. This function is useful when storing frequencies and associated data that you temporarily change in Memory Recall mode.

- 1 Press **[MR]**, then turn the **Tuning** control to recall a desired memory channel.
- 2 Press **[F]**.
- 3 Select the memory channel where you would like the data copied, using the **Tuning** control.
- 4 Press **[MR]** (**[▶]**) or **[MNU]**.

Channel 0 ~ 399	➔	Channel 0 ~ 399
Receive frequency	➔	Receive frequency
Transmit frequency	➔	Transmit frequency
Tone frequency	➔	Tone frequency
Offset direction	➔	Offset direction
CTCSS frequency	➔	CTCSS frequency
DCS code	➔	DCS code
Tone/ CTCSS/ DCS ON/ OFF status	➔	Tone/ CTCSS/ DCS ON/ OFF status
Offset frequency	➔	Offset frequency
Reverse ON	➔	Reverse ON
Frequency step size	➔	Frequency step size
Memory channel name	➔	Memory channel name
Fine Tuning ON	➔	Fine Tuning ON
Mode selection	➔	Mode selection
Memory Channel Lockout ON/ OFF	➔	Memory Channel Lockout ON/ OFF

Channel 0 ~ 399	➔	L0/U0 ~ L9/U9, Pr1, Pr2 and I-0 ~ I-9
Receive frequency	➔	Receive frequency
Transmit frequency	➔	Transmit frequency
Tone frequency	➔	Tone frequency
Offset direction	➔	Offset direction
CTCSS frequency	➔	CTCSS frequency
DCS code	➔	DCS code
Tone/ CTCSS/ DCS ON/ OFF status	➔	Tone/ CTCSS/ DCS ON/ OFF status
Offset frequency	➔	Offset frequency
Reverse ON	➔	Reverse ON
Frequency step size	➔	Frequency step size
Memory channel name	➔	Memory channel name
Fine Tuning ON	➔	Fine Tuning ON
Mode selection	➔	Mode selection
Memory Channel Lockout ON	➔	Memory Channel Lockout OFF

The tables above illustrate how data is transferred between memory channels.

Note: When transferring an odd-split channel, the Reverse status, Offset direction, and Offset frequency are not transferred (page 15).

CALL CHANNEL

The Call channel can be recalled instantly no matter what frequency the transceiver is operating on. For instance, you may use the Call channel as an emergency channel within your group. In this case, the Call Scan (page 25) will be useful.

The default Call channel frequencies are 144.000 MHz for the 2 m band, 223.000 MHz for 1.25 m band (TH-F6A), 430.000 MHz (TH-F7E)/ 440.000 MHz (TH-F6A) for the 70 cm band. Each Call channel can be reprogrammed either as a simplex or odd-split channel.

Note: Unlike Memory channels 0 to 399, the Call channel cannot be cleared. Clearing the Call channel will set it to the factory default values.

RECALLING THE CALL CHANNEL

- 1 Press **[BAND]** to select an amateur radio band.
- 2 Press **[CALL]** to recall the Call channel for that operating band.
 - The Call channel frequency and “C” appear.

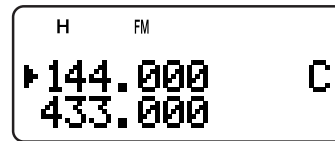

- To return to the previous frequency, press **[CALL]** again.

REPROGRAMMING THE CALL CHANNEL

- 1 Press **[BAND]** to select your desired amateur radio band.
- 2 Select your desired frequency and related data (Tone, CTCSS, DCS, or offset direction, etc.).
 - When you program the Call channel as an odd-split channel, select a receive frequency first.
- 3 Press **[F]**, **[CALL]**.
 - The selected frequency and related data are stored in the Call channel for the selected band.

To also store a separate transmit frequency, continue with the following steps.

- 4 Select the desired transmit frequency.
- 5 Press **[F]**.
- 6 Press **[PTT]+[CALL]**.
 - The separate transmit frequency is stored in the Call channel.

Note:

- ◆ The transmit frequency must be on the same band as the receive frequency band.
- ◆ Call channel data is shared between the A and B-band.
- ◆ The Reverse status cannot be stored in the Call channel.
- ◆ When you recall an odd-split Call channel, “+” and “-” appear on the display.
- ◆ Transmit offset status and Reverse status are not stored in an odd-split Call channel.
- ◆ When you revise only the transmission frequency for the odd-split Call channel, the frequency step size must be the same as the original odd-split Call channel memory data.

6 MEMORY CHANNELS

INFORMATION CHANNELS

10 Information channels are available for storing radio broadcasting service frequencies, such as weather radio stations and community FM broadcasting stations. For your conveniences, pressing **[INFO]** instantly recalls the Information channel to B-band. The following frequency data is stored by default.

Channel Number	Frequency/ Mode/ Memory Name	
	TH-F6A	TH-F7E
I-1	162.550 MHz/ FM/ WEATHER	No data (Empty)
I-2	162.400 MHz/ FM/ WEATHER	
I-3	162.475 MHz/ FM/ WEATHER	
I-4	162.425 MHz/ FM/ WEATHER	
I-5	162.450 MHz/ FM/ WEATHER	
I-6	162.500 MHz/ FM/ WEATHER	
I-7	162.525 MHz/ FM/ WEATHER	
I-8	161.650 MHz/ FM/ WEATHER	
I-9	161.775 MHz/ FM/ WEATHER	
I-0	163.275 MHz/ FM/ WEATHER	

You can revise the default channel data, such as the receiving frequencies, modes, and memory names.

RECALLING AN INFORMATION CHANNEL

Press **[INFO]** to recall the Information channels.

- "I-n" appears, where "n" represents the Information channel number from "0" ~ "9".

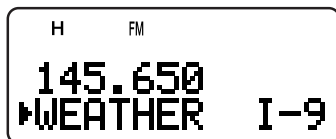

- If the B-band is selected for operation, you can turn the **Tuning** control or press **[▲]/ [▼]** to select other Information channels. If the A-band is selected for operation, press **[A/B]** to move the operation band to the B-band and then select a different Information channel.
- To exit the Information channel mode, press **[A/B]** to select the B-band then press **[VFO]** or **[MR]**.

Note: If you press **[MN<->f]**, you can display the receiving frequency in place of the memory name.

TH-F7E only: As default, no frequency data is stored in the Information channel. Store the frequency data before using the Information channels. Otherwise, an error beep sounds.

REPROGRAMMING THE INFORMATION CHANNEL

- 1 Press **[VFO]**.
- 2 Select a desired frequency and mode.
- 3 Press **[F]**.
- 4 Turn the **Tuning** control or press **[▲]/ [▼]** to select the memory channel (I-0 to I-9) in which you want to store the data.
- 5 Press **[MR] ([▶])** or **[MNU]**.
 - A long beep sounds and the Information channel data is now revised.

Note:

- ◆ When you perform the Full reset (page 50), all the Information channels recover the factory default values.
- ◆ If you clear an Information Channel data (page 16), the factory default value is recovered.
- ◆ You can also transfer the Information Channel data to the VFO or another memory channel.

CHANNEL DISPLAY

While in this mode, the transceiver displays only memory channel numbers (or memory names if stored) instead of frequencies.

1 Press **[A/B]+[⏻]** (POWER).

- The transceiver displays the memory channel number in place of the operating frequencies.

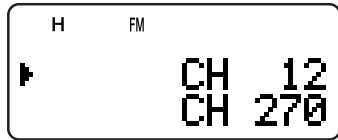

2 Turn the **Tuning** control or press **[▲]/[▼]** to select your desired memory channel number.

While in the Channel Display mode, only the following keys can be operated.

[KEY]

LAMP	MONI	LOW	BAND	A/B	INFO
SQL	BAL	REV	ENT	F	MR
CALL ¹	PTT	▲	▼	◀	▶
Tuning control		⏻			

¹ When the "1750" is selected for the CALL key.

[F] then

LAMP ¹	LOW	A/B	ENT	F
-------------------	-----	-----	-----	---

¹ The light stays ON until the key is pressed again.

[KEY] (1 s)

LAMP	INFO	MHz	F	MR
------	------	-----	---	----

While transmitting:

LAMP	MNU	1	2	3	4
5	6	7	8	9	0
*	#	A	B	C	D

When the transceiver is turned OFF, **[⏻]** (POWER) and

A/B	F
-----	---

To recover normal operation, turn the transceiver OFF and press **[A/B]+[⏻]** (POWER) again.

Note:

- To enter the Channel Display mode, you must have at least one memory channel that contains the data.
- If the memory channel contains the memory name data, the memory name is displayed in place of the "CH" characters.

Scan is a useful function for hands-off monitoring of your favorite frequencies. By becoming comfortable with all types of Scan, you will increase your operating efficiency.

This transceiver provides the following types of scans.

Scan Type		Purpose
Normal Scan	Band Scan	Scans the entire band of the frequency you selected
	Program Scan	Scans the specified frequency ranges stored in Memory channels L0/U0 ~ L9/U9
	MHz Scan	Scans the frequencies within a 1 MHz range
Memory Scan	All-Channel Scan	Scans all Memory channels from 0 to 399, based on your Menu No. 3 (MR METHOD) settings
	Group Scan	Scans the specified Memory channel groups, based on your Menu No. 2 (M.GPR LINK) settings
Call Scan	VFO	Scans the Call channel and the current VFO frequency
	Memory Channel	Scans the Call channel and the selected Memory channel
Priority Scan		Checks the activities on the specified priority channels (Pr1/ Pr2) every 3 seconds
Information Channel Scan		Scans the Information channels
Visual Scan*	VFO	Scans ± 5 frequencies in the programmed step size near the current operating frequency. The signal strength of each frequency is displayed in a bar-graph
	Memory Channel	Scans the Memory channels and displays the signal strength of each channel in a bar-graph

* Visual Scan graphically shows the busy status of frequencies in a specific range.

Note:

- ◆ When the CTCSS or DCS function is activated, the transceiver stops at a busy frequency and decodes the CTCSS tone or DCS code. If the tone or code matches, the transceiver unmutes. Otherwise, it resumes scanning.
- ◆ Press and hold **[MONI]** to pause the Scan in order to monitor the scanning frequency. Release **[MONI]** to resume scanning.
- ◆ Pressing and holding **[PTT]** causes Scan, excluding the Priority scan and Visual scan, to stop.
- ◆ Pressing **[MNU]** causes Scan to stop except the Visual Scan.
- ◆ Starting Scan switches OFF the Automatic Simplex Check (ASC) (page 14).
- ◆ If you press any key other than the following keys during the scan, the transceiver exits the Scan (excluding the Priority scan and Visual scan). The Priority scan stops while "Pr1" or "Pr2" is blinking: **[F]**, **[F] (1 s)**, **[LAMP]**, **[MONI]**, **[SQL]**, **[BAL]**, **[A/B]**, **Tuning control**, **[▲] / [▼]**, **[F]** then **[SQL]**, and **[F]** then **[LOW]**.

NORMAL SCAN

When you are operating the transceiver in VFO mode, 3 types of scanning are available: Band Scan, Program Scan, and MHz Scan.

BAND SCAN

The transceiver scans the entire band of the frequency you selected. For example, if you are operating and receiving at 144.525 MHz on the A-band, it scans all the frequencies available for the 2 m band. (Refer to receiver VFO frequency range in the specifications {page 54}.) When the current VFO receive frequency is outside of the Program Scan frequency range {page 23}, the transceiver scans the entire frequency range available for the current VFO.

- 1 Press **[VFO]**.
- 2 Press **[BAND]** to select your desired band.
- 3 Turn the **Tuning** control or press **[▲] / [▼]** to select the frequency outside of the Program Scan frequency range {page 23}.
- 4 Press **[VFO] (1 s)** to start the Band Scan.
- 5 To stop the Band Scan, press **[VFO]** or **[PTT]**.

Note:

- ◆ While scanning, you can change the scan frequency direction by turning the **Tuning** control or press **[▲] / [▼]**.
- ◆ The transceiver scans the frequency range that is stored in Menu No. 4 (PROG VFO) {page 39} on the A-band.
- ◆ If you select a frequency within the L0/U0 ~ L9/U9 range in step 3, the Program Scan {page 23} starts.
- ◆ If you press **[MONI]**, Band Scan temporarily pauses. Release **[MONI]** to resume scanning.
- ◆ The transceiver stops scanning in all modes when it detects a signal.
- ◆ If the Fine Tuning function is ON, scanning does not stop at the busy channels.

PROGRAM SCAN

You can limit the scanning frequency range. There are 10 memory channel pairs (L0/U0 ~ L9/U9) available for specifying the start and end frequencies. It monitors the range between the start and end frequencies that you have stored in memory channels L0/U0 to L9/U9. Before performing the Program Scan, store the Program Scan frequency range to one of the memory channel pairs L0/U0 ~ L9/U9.

■ Storing Program Scan Frequency Range

- 1 Press **[VFO]**.
- 2 Press **[BAND]** to select your desired band.
- 3 Turn the **Tuning** control or press **[▲]/ [▼]** to select your desired start frequency.
- 4 Press **[F]**, then turn the **Tuning** control or press **[▲]/ [▼]** to select a memory channel from L0 ~ L9.

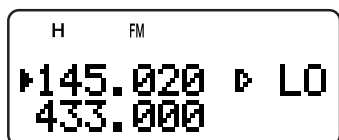

- 5 Press **[MR] ([▶])** or **[MNU]** to store the start frequency in the memory channel.
- 6 Turn the **Tuning** control or press **[▲]/ [▼]** to select your desired end frequency.
- 7 Press **[F]**, then Turn the **Tuning** control or press **[▲]/ [▼]** to select the corresponding channel from U0 ~ U9 (you must select the same numeric value as in step 4).
 - For example, if you selected L0 in step 4, you must select U0 in this step.

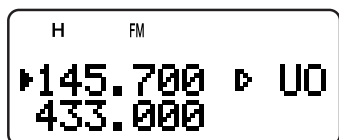

- 8 Press **[MR] ([▶])** or **[MNU]** to store the end frequency in the memory channel.

■ Performing the Program Scan

- 1 Press **[VFO]**.
- 2 Turn the **Tuning** control or press **[▲]/ [▼]** to select a frequency within the frequency range of memory channel L0/U0 ~ L9/U9.
- 3 Press **[VFO] (1 s)** to start the Program Scan.
- 4 To stop the Program Scan, press **[VFO]** or **[PTT]**.

Note:

- ◆ If you press **[MONI]**, Program Scan temporarily pauses. Release **[MONI]** to resume scanning.
- ◆ If the Fine Tuning function is ON, the scanning does not stop at the busy channels.
- ◆ The transceiver stops scanning in all modes when it detects a signal.
- ◆ If more than 2 Program Scan channel pairs are stored and overlaps the frequency range among the pairs, the smaller Program Scan memory channel number has the priority.

- ◆ To perform the Program Scan, the following conditions must be met. Otherwise, the Band scan starts (page 22).
 - The upper and lower limit frequencies are in the same frequency band.
 - $L_n < U_n$ (where "n" is the Program Scan channel number).

MHz SCAN

MHz Scan allows you to scan an entire 1 MHz frequency range within the current VFO frequency.

- 1 Press **[VFO]**.
- 2 Turn the **Tuning** control or press **[▲]/ [▼]** to select a frequency in which to perform the MHz Scan. If you want to scan the entire 145 MHz frequency, select any frequency between 145.000 and 149.995 MHz (for example, select 145.650 MHz). Scan will operate between 145.000 MHz and 145.999 MHz.
- 3 Press **[MHz] (1 s)** to start the MHz Scan.
- 4 To stop the MHz Scan, press **[MHz]** or **[PTT]**.

Note:

- ◆ If the Fine Tuning function is ON, you cannot perform the MHz Scan.
- ◆ If you press **[MONI]**, MHz Scan temporarily pauses. Release **[MONI]** to resume scanning.

7 SCAN

MEMORY SCAN

Memory Scan monitors all memory channels in which you have stored frequencies (All-Channel Scan) or only a desired group of memory channels (Group Scan).

ALL-CHANNEL SCAN

The transceiver scans all of the memory channels in which you have stored frequencies.

- 1 Press **[MR]** (1 s).
 - Scan starts from the last memory channel number and ascends up through the channel numbers (default). Turn the **Tuning** control or press **[▲]/ [▼]** to change the scanning direction.
 - To jump to a desired channel while scanning, quickly turn the **Tuning** control.
- 2 To stop the All-Channel Scan, press **[MR]** or **[PTT]**.

Note:

- ◆ You must have 2 or more memory channels that contain the data, excluding the special function memory channels.
- ◆ If "CURRENT BAND" is selected for Menu No. 3 (MR METHOD), it scans only Memory channels that have the same frequency band data.
- ◆ The transceiver stops scanning in all modes when it detects a signal.

GROUP SCAN

In order to easily manage all 400 memory channels, they are divided into 8 groups {page 18}. For the purpose of Group Scan, you can select a particular memory group to be scanned, depending on the situation. Using the Memory Group Link function {below}, you can scan all the linked memory groups.

- 1 Press **[MR]**.
- 2 Turn the **Tuning** control or press **[▲]/ [▼]** to select a memory channel in the group you want to scan. For example, if you want to scan the group 0 memory channels, recall memory channel 12 (group 0 contains memory channels 0 ~ 49).

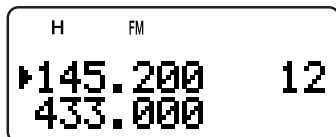

- 3 Press **[MHz]** (1 s).
 - The memory channels within the selected group are scanned.
 - If the group is linked to other groups {below}, all the linked groups are also scanned.
- 4 To stop the Group Scan, press **[MHz]** or **[PTT]**.

Note:

- ◆ You must have 2 or more memory channels that contain the data, excluding the special function memory channels.
- ◆ The Group Scan scans all available memory channels, regardless of Menu No. 3 (MR METHOD) selection {page 16}.
- ◆ The transceiver stops scanning in all modes when it detects a signal.

Memory Group Link

Although the 400 memory channels are divided into 8 groups {page 18}, you may sometimes want to scan two or more groups. In this case, use the Memory Group Link function.

- 1 Press **[MNU]** to enter Menu mode.
- 2 Turn the **Tuning** control or press **[▲]/ [▼]** to select Menu No. 2 (M.GRP LINK).
- 3 Press **[▶]** or **[MNU]**.
 - The memory group numbers appear.



- 4 Move the cursor using **[◀]/ [▶]**, then turn the **Tuning** control or press **[▲]/ [▼]** to select or deselect the group to be linked.
 - Linked groups appear at the bottom of the display (in the example below, groups 0, 1, 3 and 5 are linked).

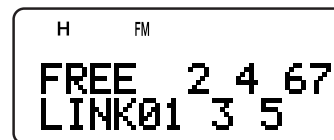

- 5 Press **[▶]** or **[MNU]** to store the setting. Otherwise, press **[◀]** or **[PTT]** to cancel.
 - You can press **[MONI]** to cancel the all links at once.
 - You can also press **[0] ~ [7]** to select or deselect the group to be linked.

CALL SCAN

A Call channel can be stored for each amateur radio band, such as the 2 m, 70 cm, and 1.25 m (TH-F6A only) bands {page 19}. You can monitor one of these Call channels and the current operating frequency alternatively.

- 1 Select the frequency (in VFO, Memory Recall, or Information Channel mode) you want to monitor.
 - In VFO mode, press **[A/B]** to select the A or B-band. Then, turn the **Tuning** control or press **[▲]/ [▼]** to select the desired frequency.
 - In Memory Recall mode, turn the **Tuning** control or press **[▲]/ [▼]** to select a memory channel you want to monitor.
 - Press **[INFO]** to recall the last Information Channel you monitored.
- 2 Press **[CALL]** (1 s) to start the Call Scan.
- 3 The Call channel for the band and the selected VFO frequency, memory channel or Information Channel are monitored alternately.
- 4 To stop the Call Scan, press **[PTT]** or **[CALL]**.

Note:

- ◆ The transceiver stops scanning in all modes when it detects a signal.
- ◆ You can perform the Call Scan even if the recalled memory channel or Information channel has been locked out {page 27}.
- ◆ If the Call channel is not available for the current operating frequency, an error beep sounds.

PRIORITY SCAN

You may sometimes want to check your favorite frequency activities while monitoring the A and B-bands. In this case, use the Priority Scan function. It checks the activities of Pr1 and Pr2 channels every 3 seconds, alternately, using the B-band receiver. If the transceiver detects a signal on Pr1 or Pr2, it recalls the frequency to the B-band receiver.

Note: If you do not operate any control or key for 3 seconds after the signal drops, the transceiver returns to the original frequency and resumes Priority Scan.

PROGRAMMING PRIORITY CHANNELS

- 1 Press **[VFO]**.
- 2 Turn the **Tuning** control or press **[▲]/ [▼]** to select your desired priority channel frequency.
- 3 Select the mode and selective call functions, if necessary.
- 4 Press **[F]**.
 - The memory channel number appears.
- 5 Turn the **Tuning** control or press **[▲]/ [▼]** to select "Pr1".

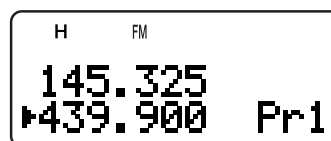

- 6 Press **[MR]** (**[▶]**) or **[MNU]**) to store the data on the priority channel.
 - If you want to store a second priority channel, repeat steps 1 ~ 6 and select "Pr2" in step 5.

Note: You can program any frequency available on the B-band as a priority channel.

USING PRIORITY SCAN

- 1 Press **[F]**, **[BAL]**.

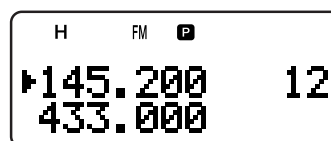

- "P" appears.
 - The transceiver checks for a signal on the Pr1 and Pr2 channels every 3 seconds, alternately.
 - When the transceiver detects a signal on the priority channel, "Pr1" or "Pr2" blinks and the B-band frequency changes to the priority channel.
 - If you do not operate any control or key for 3 seconds after the signal drops, the transceiver returns to the original frequency and resumes Priority Scan.
- 2 To quit Priority Scan, press **[F]**, **[BAL]** again.

7 SCAN

Note:

- ◆ The signal being received on the B-band may become intermittent because the Priority Scan uses the B-band receiver to check the priority channel(s) activities.
- ◆ When a signal is received on a Priority channel with a CTCSS or DCS code programmed, the Priority channel is recalled even if a different selective tone/ code is detected. However, the transceiver only unmutes if the signal has the same CTCSS tone or DCS code.
- ◆ If the Tone Alert function (page 40) is ON for the B-band, it overrides the Priority Scan function. This means that you cannot monitor the received signal on the Priority Channels nor transmit on the Priority Channels.
- ◆ Press and hold **[MONI]** to pause the Priority Scan when the transceiver is not displaying a priority channel. Release **[MONI]** to resume the Priority Scan.
- ◆ If you clear the Priority Channels (page 16), the Priority Scan stops.
- ◆ If you press any key other than the following keys while "Pr1" or "Pr2" is blinking, the transceiver exits the Priority Scan: **[LAMP]**, **[MONI]**, **[A/B]**, **[SQL]**, **[BAL]**, **[F]** (1 s), and **[PTT]**.
- ◆ If you perform the Visual Scan (below) while Priority Scan is activated, the Priority Scan temporarily pauses.

INFORMATION CHANNEL SCAN

Information Channel Scan is similar to Group Scan. However, it scans only Information channels.

- 1 Press **[INFO]**.
 - The last Information channel you used is recalled.
- 2 Press **[INFO]** (1 s) to start the Information Channel Scan.
- 3 To stop the Information Channel Scan, press **[INFO]**.
 - If necessary, press **[A/B]** to select the B-band and then press **[VFO]** or **[MR]** to select another frequency (channel) for the B-band.

Note: The transceiver stops scanning in all modes when it detects a signal.

VISUAL SCAN

While you are receiving, Visual Scan allows you to monitor frequencies near the current operating frequency. Visual Scan graphically displays the busy status of all frequencies in the selected range on the other band display area. You will see 6 different bar-graph levels, for each frequency (channel) point that represent relative S-meter levels.

The Visual Scan monitors ± 5 channels (frequencies) by centering on the current channel (frequency). In this way, a total of 11 channels' (frequencies') signal strength status are graphically displayed.

Note:

- ◆ When you perform the Visual Scan on the A-band, the transceiver can output the audio. However, when you perform the Visual Scan on the B-band, it cannot output the audio. The S-meter does not reflect the signal strength, neither.
- ◆ When the VOX function is activated, you cannot perform the Visual Scan.
- ◆ When the Visual Scan is in progress, the other scan functions.

USING VISUAL SCAN (VFO)

- 1 Select your desired band for Visual Scan.
- 2 Press **[VFO]**.
- 3 Turn the **Tuning** control or press **[▲]/ [▼]** to select your desired center frequency.
 - The transceiver scans the 5 upper frequencies and 5 lower frequencies using the current VFO frequency step (page 37).
- 4 Press **[F]**, **[INFO]** to start Visual Scan (VFO).

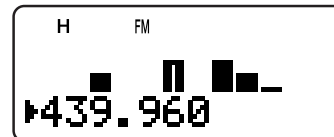

- The scanning frequency is displayed on the current operating band and the relative S-meter level of each frequency appears on the other band display.
 - To pause Scan, press and hold **[MONI]**. While the Visual Scan is paused, the center frequency bar-graph blinks and you can monitor the frequency. Release **[MONI]** to resume the Visual Scan.
- 5 To change the current scanning frequency, Turn the **Tuning** control or press **[▲]/ [▼]**.
 - The displayed frequency changes and the cursor moves.
 - 6 To stop the Visual Scan, press **[F]**, **[INFO]**.

Note:

- ◆ You can press **[PTT]** (or **[CALL]** if 1750 Hz is programmed) to transmit during the scan if the center frequency is within the transmission frequency range. The center bar-graph blinks while transmitting.
- ◆ If the Fine Tuning function is ON, the Visual Scan cancels the Fine Tuning function and automatically adjusts the frequency to the next available frequency.

USING VISUAL SCAN (MEMORY CHANNEL)

- 1 Press **[MR]** to enter Memory Recall mode.
- 2 Turn the **Tuning** control or press **[▲]/ [▼]** to select your desired center memory channel.
- 3 Press **[F]**, **[INFO]** to start the Visual Scan.

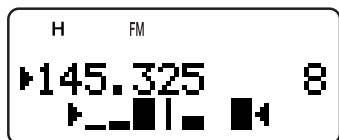

- The transceiver start scanning the 5 upper memory channels and 5 lower memory channels, by centering the selected memory channel.
 - The current scanning memory channel number and frequency are displayed on the current operating band. On the other band, the relative S-meter level of each frequency channel is displayed.
 - To pause Scan, press and hold **[MONI]**. While the Visual Scan is paused, the center frequency bar-graph blinks and you can monitor the frequency. Release **[MONI]** to resume the Visual Scan.
- 4 To change the current scanning channel, turn the **Tuning** control or press **[▲]/ [▼]**.
 - 5 To stop the Visual Scan, press **[F]**, **[INFO]**.

Note:

- ◆ You can press **[PTT]** (or **[CALL]** if 1750 Hz is programmed) to transmit during the scan if the center frequency is within the transmission frequency range. The center bar-graph blinks while transmitting.
- ◆ If 11 or more memory channels are stored, "▶" and "◀" do not appear.
- ◆ Even if the Fine Tuning ON status is stored in the memory channels, the Visual Scan (Memory Channel) starts.

MEMORY CHANNEL LOCKOUT

You can lock out memory channels that you prefer not to monitor during Memory Scan.

- 1 Press **[MR]** to enter Memory Recall mode.
- 2 Turn the **Tuning** control or press **[▲]/ [▼]** to select the memory channel to be locked out.
- 3 Press **[F]**, **[MHz]**.
 - "★" appears at the top right of the memory channel number, indicating the channel is locked out.

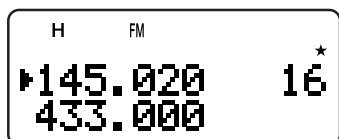

- 4 To unlock the memory channel, repeat steps 1 ~ 3.
 - "★" disappears.

Note:

- ◆ The Program Scan memories (L0/U0 ~ L9/U9) and Priority channels (Pr1 and Pr2) cannot be locked out.
- ◆ Even if a memory channel is locked out, you can perform the Call Scan (page 25) between the Call channel and memory channel.
- ◆ If the same memory channel is recalled to the A and B-band, you cannot lock out the channel.

SCAN RESUME METHOD

The transceiver stops scanning at the frequency (or memory channel) where a signal is detected. It then continues or stops scanning according to which resume mode you have selected.

Time-Operated mode (default)

The transceiver remains on a busy frequency (or memory channel) for approximately 5 seconds, then continues to scan, even if the signal is still present.

Carrier-Operated mode

The transceiver remains on the busy frequency (or memory channel) until the signal drops out. There is a 2-second delay between signal dropout and scan resumption.

Seek mode

The transceiver moves to a frequency or memory channel where a signal is present and stops.

To change the scan resume method:

- 1 Press **[MNU]**.
- 2 Turn the **Tuning** control or press **[▲]/ [▼]** to select Menu No. 1 (SCAN RESUME).

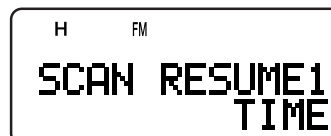

- 3 Press **[▶]** or **[MNU]**.
- 4 Turn the **Tuning** control or press **[▲]/ [▼]** to select "TIME" (Time-Operated mode), "CARRIER" (Carrier-Operated mode), or "SEEK" (Seek mode).
- 5 Press **[▶]** or **[MNU]** to store the setting. Otherwise, press **[◀]** or **[PTT]** to cancel.

CTCSS and DCS

You may sometimes want to hear calls from only specific persons or groups. In this case, use the selective call function. This transceiver is equipped with CTCSS (Continuous Tone Coded Squelch System) and DCS (Digital Coded Squelch). These selective calls allow you to ignore (not hear) unwanted calls from other persons who are using the same frequency. The transceiver unmutes only when it receives the signal having the same CTCSS tone or DCS code.

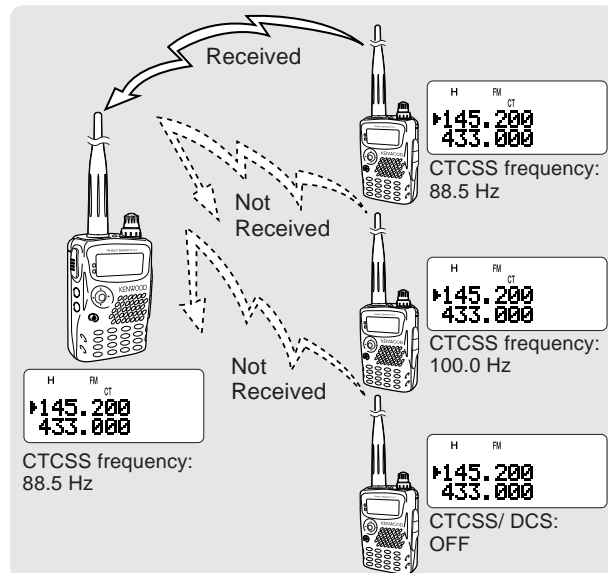

Note:

- ◆ CTCSS and DCS do not cause your conversation to be private or scrambled. It only relieves you from listening to unwanted conversations.
- ◆ CTCSS and DCS function in only FM mode.

CTCSS

A CTCSS tone is a sub-audible tone and is selectable from among the 42 tone frequencies listed in the table on the following page. The list includes 37 EIA standard tones and 5 non-standard tones. You can select one of the tones to use as a CTCSS tone.

USING CTCSS

Press **[TONE]** until "CT" appears.

- Each time you press **[TONE]**, the icon cycles as follows: "T" (TONE) → "CT" (CTCSS) → "DCS" (DCS) → " " (OFF) → "T" (TONE).

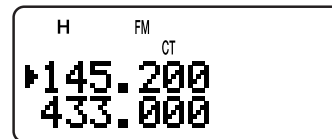

When the CTCSS function is ON, you will hear calls only when the selected CTCSS tone is received. To answer the call, press and hold the **PTT** switch, then speak into the microphone.

Note:

- ◆ You cannot use the CTCSS and Tone/ DCS functions simultaneously. Switching the CTCSS function ON after having activated the Tone/ DCS functions deactivates the Tone/ DCS functions.
- ◆ If you select a high CTCSS frequency, receiving audio or noise that contains the same frequency portions may cause CTCSS to function incorrectly. To prevent noise from causing this problem, select an appropriate squelch level (page 6).
- ◆ While transmitting the 1750 Hz tone by pressing **[CALL]** (page 13), the transceiver does not transmit the CTCSS tone.

SELECTING A CTCSS FREQUENCY

- 1 While in CTCSS mode (above), press **[F]**, **[TONE]**.
 - The current CTCSS frequency appears.

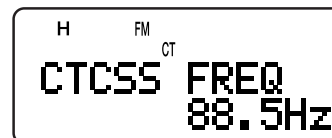

- 2 Turn the **Tuning** control or press **[▲]**/ **[▼]** to select your desired CTCSS frequency.
 - The selectable CTCSS frequencies are the same as those for the Tone frequency. Refer to the table on the following page for the available CTCSS frequencies.
- 3 Press **[▶]** or **[MNU]** to store the new setting. Otherwise, press **[◀]** or **[PTT]** to cancel.

CTCSS FREQ. ID SCAN

This function scans through all CTCSS frequencies to identify the incoming CTCSS frequency on the received signal. You may find this useful when you cannot recall the CTCSS frequency that the other persons in your group are using.

- 1 While the CTCSS function is ON, press [F], [TONE] (1 s) to start the CTCSS Freq. ID Scan function.

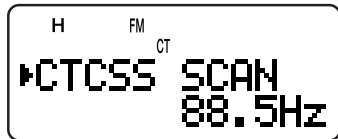

- To reverse the scan direction, turn the **Tuning** control or press [▲]/ [▼].
 - To quit the function, press [◀] or [PTT].
 - When a CTCSS frequency is identified, the identified frequency appears and blinks.
- 2 Press [▶] or [MNU] to program the identified frequency in place of the current CTCSS frequency. Otherwise, press [◀] if you do not want to program the identified frequency.
 - Turn the **Tuning** control or press [▲]/ [▼] while the identified frequency is blinking to resume scanning.

Available CTCSS frequencies

No.	Freq. (Hz)	No.	Freq. (Hz)	No.	Freq. (Hz)	No.	Freq. (Hz)
01	67.0	12	97.4	23	141.3	34	206.5
02	69.3	13	100.0	24	146.2	35	210.7
03	71.9	14	103.5	25	151.4	36	218.1
04	74.4	15	107.2	26	156.7	37	225.7
05	77.0	16	110.9	27	162.2	38	229.1
06	79.7	17	114.8	28	167.9	39	233.6
07	82.5	18	118.8	29	173.8	40	241.8
08	85.4	19	123.0	30	179.9	41	250.3
09	88.5	20	127.3	31	186.2	42	254.1
10	91.5	21	131.8	32	192.8		
11	94.8	22	136.5	33	203.5		

Note:

- ◆ Received signals are monitored through the speaker while scanning is in progress.
- ◆ CTCSS Freq. ID Scan does not scan the tone if a signal is not detected.
- ◆ If the CTCSS function is activated for both the A and B-band, the scan speed may be slower.

DCS

DCS is similar to CTCSS. However, instead of using an analog audio tone, it uses a continuous sub-audible digital waveform that represents a 3-digit octal number. You can select a DCS code from among the 104 DCS codes listed in the table below.

USING DCS

Press [TONE] until "DCS" appears.

- Each time you press [TONE], the icon cycles as follows: "T" (TONE) → "CT" (CTCSS) → "DCS" (DCS) → " " (OFF) → "T" (TONE).

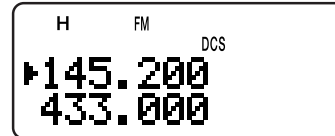

When the DCS function is ON, you will hear calls only when the selected DCS code is received. To answer the call, press and hold the PTT switch, then speak into the microphone.

Note: You cannot use the DCS function and CTCSS/ Tone functions simultaneously. Switching the DCS function ON after having activated the CTCSS/ Tone functions deactivate the CTCSS/ Tone functions.

SELECTING A DCS CODE

- 1 While in DCS mode (above), press [F], [TONE].
 - The current DCS code appears.

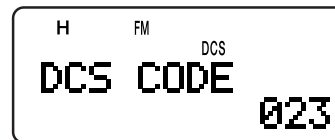

- 2 Turn the **Tuning** control or press [▲]/ [▼] to select your desired DCS code.
 - The available DCS codes are shown in the following table.

023	065	132	205	255	331	413	465	612	731
025	071	134	212	261	332	423	466	624	732
026	072	143	223	263	343	431	503	627	734
031	073	145	225	265	346	432	506	631	743
032	074	152	226	266	351	445	516	632	754
036	114	155	243	271	356	446	523	654	
043	115	156	244	274	364	452	526	662	
047	116	162	245	306	365	454	532	664	
051	122	165	246	311	371	455	546	703	
053	125	172	251	315	411	462	565	712	
054	131	174	252	325	412	464	606	723	

- 3 Press [▶] or [MNU] to store the new setting. Otherwise, press [◀] or [PTT] to cancel.

8 SELECTIVE CALL

DCS CODE ID SCAN

This function scans through all DCS codes to identify the incoming DCS code on the received signal. You may find this useful when you cannot recall the DCS code that the other persons in your group are using.

- 1 While in DCS mode, press **[F]**, **[TONE]** (1 s) to start the DCS Code ID Scan function.

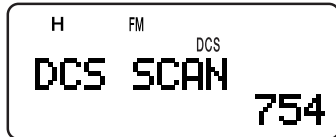

- To reverse the scan direction, turn the **Tuning** control or press **[▲]** / **[▼]**.
 - To quit the function, press **[←]** or **[PTT]**.
 - When a DCS code is identified, the identified code appears and blinks.
- 2 Press **[▶]** or **[MNU]** to program the identified frequency in place of the current DCS code. Otherwise, press **[←]** if you do not want to program the identified code.
 - Turn the **Tuning** control or press **[▲]** / **[▼]** while the identified DCS code is blinking to resume scanning.

Note:

- ◆ Received signals are monitored through the speaker while scanning is in progress.
- ◆ DCS Code ID Scan does not scan the code if a signal is not detected.
- ◆ If the DCS function is activated for both the A and B-band, the scan speed may be slower.

DTMF FUNCTIONS

The keys on the keypad also function as DTMF keys; the 12 keys found on a touch-tone phone plus 4 additional keys (A, B, C, D). This transceiver also provides 10 dedicated DTMF memory channels. You can store a DTMF number (16 digits max.) with a memory name (8 digits max.) in each of the channels to recall later for speed dialing.

Many repeaters in the U.S.A. and Canada offer a service called Autopatch. You can access the public telephone network via such a repeater by sending DTMF tones. For further information, consult your local repeater reference.

MANUAL DIALING

Manual Dialing requires only two steps to send DTMF tones.

- 1 Press and hold the **PTT** switch to transmit.
- 2 While transmitting, press the keys in sequence on the keypad to send DTMF tones.
 - The corresponding DTMF tones are transmitted and monitored through the speaker.
 - While pressing keys on the keypad, the transceiver remains in the TX mode. You do not have to press **[PTT]** at the same time.

Freq. (Hz)	1209	1336	1477	1633
697	1	2	3	A
770	4	5	6	B
852	7	8	9	C
941	*	0	#	D

DTMF TX HOLD

This function causes the transceiver to remain in transmit mode for 2 seconds after you release each key. So, you can release the **PTT** switch while sending the DTMF tones.

- 1 Press **[MNU]** to enter Menu mode.
- 2 Turn the **Tuning** control or press **[▲]/ [▼]** to select Menu No. 12 (DTMF HOLD).
- 3 Press **[▶]** or **[MNU]**.
- 4 Turn the **Tuning** control or press **[▲]/ [▼]** to select "ON".



- 5 Press **[▶]** or **[MNU]** to store the setting. Otherwise, press **[◀]** or **[PTT]** to cancel.

AUTOMATIC DIALER

If you use the 10 dedicated memory channels to store DTMF numbers, you need not remember a long string of digits.

STORING A DTMF NUMBER IN MEMORY

Note: Audible DTMF tones from other transceivers near you (or from your own speaker) may be picked up by your microphone. If so, you may fail to correctly program a DTMF number.

- 1 Press **[MNU]** to enter Menu mode.
- 2 Turn the **Tuning** control or press **[▲]/ [▼]** to select Menu No. 10 (DTMF STORE).
- 3 Press **[▶]** or **[MNU]**.



- 4 Turn the **Tuning** control or press **[▲]/ [▼]** to select your desired DTMF memory channel number from 0 to 9.
- 5 Press **[▶]** or **[MNU]**.
 - The display for entering a memory name appears; the first digit blinks.
 - To skip naming the channel, press **[▶]** or **[MNU]** again; jump to step 9.



- 6 Turn the **Tuning** control or press **[▲]/ [▼]** to select a character. Refer to "NAMING A MEMORY CHANNEL" {page 17} for the available characters and the input method.
 - You can enter alphanumeric characters plus special ASCII characters.
 - Press **[MONI]** to delete the character at the cursor.
 - You can also use the numeric keypad to enter a character (special ASCII characters are not available). For example, each press of **[2]** switches entry as a, b, c, 2, A, B, C and then back to a.
 - While pressing and holding **[LAMP]**, turn the **Tuning** control to jump to the first character of each ASCII character group {page 17}.
- 7 Press **[▶]** to move the cursor to the next digit.
- 8 Repeat steps 6 and 7 to enter up to 8 digits.



9 DTMF FUNCTIONS

- Pressing [▶] after selecting the 8th digit completes the programming.
- To complete programming a name with less than 8 digits, press [MNU] or [▶] twice.
- Each press of [◀] causes the cursor to move backward.

- 9 Press the keys in sequence on the keypad to enter a DTMF number with up to 16 digits.



- You can also turn the **Tuning** control or press [▲]/ [▼] to select the required DTMF number for each digit. Select a space if you want to put a pause.
- Press [MONI] to delete a number at the cursor.

- 10 Press [▶] or [MNU] to complete the programming.

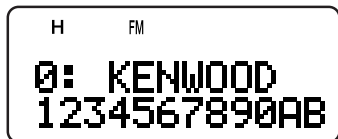

You can confirm the stored DTMF number by using steps 1 to 4.

TRANSMITTING A STORED DTMF NUMBER

- 1 While pressing and holding [PTT], press [MNU].
- 2 Release only [MNU], then turn the **Tuning** control or press [▲]/ [▼] to select the desired DTMF memory channel.
- 3 While still holding [PTT], press [▶] or [MNU] to transmit the DTMF tones.

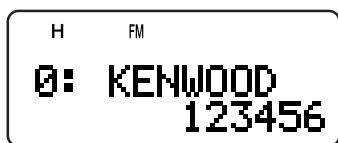

- The number stored in the channel scrolls across the display accompanied by DTMF tones from the speaker.
- After transmission, the frequency display is restored.

If you do not need to confirm the memory channel contents, press [0] to [9] instead of turning the **Tuning** control or pressing [▲]/ [▼] in step 2 to select a channel number. The stored DTMF number will be immediately transmitted. You need not press [▶] or [MNU] in step 3.

Note: If you select an empty DTMF memory channel and press [MNU] or [▶], an error beep sounds and the frequency display is restored.

ADJUSTING THE DTMF TONE TRANSMISSION SPEED

This transceiver allows you to configure the DTMF number transmission speed between Fast (default) and Slow. If a repeater cannot respond to the fast speed, adjust this parameter.

- 1 Press [MNU] to enter Menu mode.
- 2 Turn the **Tuning** control or press [▲]/ [▼] to select Menu No. 11 (DTMF SPD).
- 3 Press [▶] or [MNU].
- 4 Turn the **Tuning** control or press [▲]/ [▼] to select "FAST" (default) or "SLOW".
 - The tone duration of FAST is 50 ms and SLOW is 100 ms.
- 5 Press [▶] or [MNU] to store the setting. Otherwise, press [◀] or [PTT] to cancel.

ADJUSTING THE PAUSE DURATION

You can also change the pause duration (a space digit) stored in memory channels; the default is 500 ms.

- 1 Press [MNU] to enter Menu mode.
- 2 Turn the **Tuning** control or press [▲]/ [▼] to select Menu No. 13 (DTMF PAUSE).
- 3 Press [▶] or [MNU].
- 4 Turn the **Tuning** control or press [▲]/ [▼] to select 100/ 250/ 500 (default)/ 750/ 1000/ 1500/ 2000 ms.
- 5 Press [▶] or [MNU] to store the setting. Otherwise, press [◀] or [PTT] to cancel.

DTMF LOCK

Assuming you have a transceiver with the optional speaker microphone installed and you are carrying it in the holder or bag, you sometimes may want to disable the keypad DTMF transmission to avoid accidental DTMF transmission. In this case, turn the DTMF Lock function ON.

- 1 Press [MNU] to enter Menu mode.
- 2 Turn the **Tuning** control or press [▲]/ [▼] to select Menu No. 14 (DTMF LOCK).
- 3 Press [▶] or [MNU].
- 4 Turn the **Tuning** control or press [▲]/ [▼] to select "ON".
- 5 Press [▶] or [MNU] to store the setting. Otherwise, press [◀] or [PTT] to cancel.

When this function is activated, you cannot transmit DTMF tones using the DTMF keypad (including [MNU]) during transmission.

UTILIZING THE B-BAND

ABOUT THE B-BAND

Usually you can communicate with other amateur radio stations using A-band frequencies for receiving and transmitting. This transceiver also features another receiver in addition to the A-band transceiver. The frequency for the B-band appears on the bottom part of the display. Although the A-band transceiver covers only the 2 m/ 1.25 m (TH-F6A only)/ 70 cm amateur radio bands in FM mode, the B-band receiver can receive signals from 100 kHz to 470 MHz in SSB, CW, FM, or AM mode, and from 470 MHz to 1.3 GHz in FM or AM mode.

In this way, you can monitor 2 different frequencies at the same time. For example, you can listen to a local FM broadcasting station on the B-band while you are monitoring your club channel on the A-band.

If one of the A-band amateur radio bands is selected for the B-band receiver in FM mode, you can also transmit on the B-band frequency.

B-BAND FREQUENCY

Since the B-band frequency coverage is so wide, the default frequency band, mode, and frequency step size are preprogrammed as shown below.

- Press **[A/B]** to select B-band.
 - The “▶” icon moves, indicating which band is currently selected for operation.
- Press **[BAND]** until the desired frequency band appears.
 - Each time you press **[BAND]**, the frequency band cycles from the last band you selected to the upper band frequency. When it reaches the 23 cm band, it returns to the AM band.
 - You can also press **[◀]/ [▶]** to select your desired band in VFO mode {page 7}.

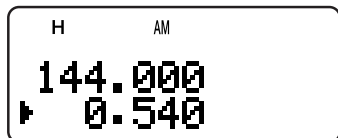

- Turn the **Tuning** control or press **[▲]/ [▼]** to tune to a desired frequency.

Note: You can also select one of the amateur radio bands to transmit on the B-band frequency. However, you must be operating in FM mode to transmit.

■ B-band Frequency Coverage (TH-F6A)

Band	Frequency	Step	Mode
AM band	100 kHz ~ 520 kHz	5 kHz	AM
	520 kHz ~ 1.8 MHz	10 kHz	AM
HF	1.8 MHz ~ 3.5 MHz	100 Hz (FINE ON)	AM
	3.5 MHz ~ 4.0 MHz		LSB
	4.0 MHz ~ 7.0 MHz		AM
	7.0 MHz ~ 7.3 MHz		LSB
	7.3 MHz ~ 10.1 MHz		AM
	10.1 MHz ~ 10.15 MHz		CW
	10.15 MHz ~ 14.0 MHz		AM
	14.0 MHz ~ 14.35 MHz		USB
	14.35 MHz ~ 18.068 MHz		AM
	18.068 MHz ~ 18.168 MHz		USB
	18.168 MHz ~ 21.0 MHz		AM
	21.0 MHz ~ 21.45 MHz		USB
	21.45 MHz ~ 24.89 MHz		AM
	24.89 MHz ~ 24.99 MHz		USB
24.99 MHz ~ 28.0 MHz	AM		
28.0 MHz ~ 29.7 MHz	USB		
6 m	29.7 MHz ~ 50.0 MHz	25 kHz	FM
	50.0 MHz ~ 54.0 MHz	10 kHz	
FM band	54.0 MHz ~ 108.0 MHz	100 kHz	FMW
Air band	108.0 MHz ~ 137.0 MHz	12.5 kHz	AM
2 m	137.0 MHz ~ 144.0 MHz	5 kHz	FM
	144.0 MHz ~ 148.0 MHz	5 kHz	
	148.0 MHz ~ 174.0 MHz	5 kHz	
VHF TV	174.0 MHz ~ 216.0 MHz	50 kHz	FMW
1.25 m	216.0 MHz ~ 220.0 MHz	12.5 kHz	FM
	220.0 MHz ~ 225.0 MHz	20 kHz	
	225.0 MHz ~ 400.0 MHz	12.5 kHz	
70 cm	400.0 MHz ~ 420.0 MHz	12.5 kHz	
	420.0 MHz ~ 450.0 MHz	25 kHz	
450.0 MHz ~ 470.0 MHz	12.5 kHz		
UHF TV	470.0 MHz ~ 806.0 MHz	50 kHz	FMW
23 cm	806.0 MHz ~ 1240.0 MHz	12.5 kHz	FM
	1240.0 MHz ~ 1300.0 MHz	25 kHz	

Note:

- ◆ By default, the Fine Tuning function is activated automatically for 1.8 MHz ~ 29.7 MHz.
- ◆ Cellular band is blocked due to government regulations.

10 UTILIZING THE B-BAND

■ B-band Frequency Coverage (TH-F7E)

Band	Frequency	Step	Mode
AM band	100 kHz ~ 520 kHz	5 kHz	AM
	520 kHz ~ 1.71 MHz	10 kHz	AM
HF	1.71 MHz ~ 3.5 MHz	100 Hz (FINE ON)	AM
	3.5 MHz ~ 4.0 MHz		LSB
	4.0 MHz ~ 7.0 MHz		AM
	7.0 MHz ~ 7.3 MHz		LSB
	7.3 MHz ~ 10.1 MHz		AM
	10.1 MHz ~ 10.15 MHz		CW
	10.15 MHz ~ 14.0 MHz		AM
	14.0 MHz ~ 14.35 MHz		USB
	14.35 MHz ~ 18.068 MHz		AM
	18.068 MHz ~ 18.168 MHz		USB
	18.168 MHz ~ 21.0 MHz		AM
	21.0 MHz ~ 21.45 MHz		USB
	21.45 MHz ~ 24.89 MHz		AM
	24.89 MHz ~ 24.99 MHz		USB
24.99 MHz ~ 28.0 MHz	AM		
6 m	29.7 MHz ~ 46.0 MHz	5 kHz	FM
	46.0 MHz ~ 50.0 MHz	50 kHz	FMW
	50.0 MHz ~ 52.0 MHz	10 kHz	FM
	52.0 MHz ~ 68.0 MHz	50 kHz	FMW
	68.0 MHz ~ 87.5 MHz	5 kHz	FM
FM band	87.5 MHz ~ 108.0 MHz	50 kHz	FMW
Air band	108.0 MHz ~ 137.0 MHz	25 kHz	AM
	137.0 MHz ~ 144.0 MHz	5 kHz	FM
	144.0 MHz ~ 146.0 MHz	12.5 kHz	
2 m	146.0 MHz ~ 174.0 MHz	5 kHz	FM
	174.0 MHz ~ 230.0 MHz	50 kHz	
	230.0 MHz ~ 400.0 MHz	12.5 kHz	
70 cm	400.0 MHz ~ 430.0 MHz	12.5 kHz	FM
	430.0 MHz ~ 440.0 MHz	25 kHz	
	440.0 MHz ~ 470.0 MHz	12.5 kHz	
UHF TV	470.0 MHz ~ 862.0 MHz	50 kHz	FMW
	862.0 MHz ~ 1240.0 MHz	12.5 kHz	FM
23 cm	1240.0 MHz ~ 1300.0 MHz	25 kHz	

Note: By default, the Fine Tuning function is activated automatically for 1.71 MHz ~ 29.7 MHz.

SELECTING A MODE FOR THE B-BAND

When using the B-band receiver, the following receiving mode is available.

Receiving Mode	Available Frequency Ranges
LSB/ USB	100 kHz ≤ f < 470 MHz
CW	100 kHz ≤ f < 470 MHz
AM	100 kHz ≤ f < 1.3 GHz
FM	100 kHz ≤ f < 1.3 GHz
WFM	29.7 MHz ≤ f < 1.3 GHz

LSB/ USB/ CW/ AM/ FM/ WFM

To select the receiving mode for the B-band:

- 1 Press **[VFO]**.
- 2 Press **[A/B]** to select the B-band.
- 3 Press **[BAND]**, then turn the **Tuning** control or press **[▲]/ [▼]** to select the desired frequency.
- 4 Press **[F]**, **[BAND]** repeatedly until you select the desired receiving mode. The mode icon cycles from FM → WFM → AM → LSB → USB → CW, and then goes back to FM.

Note:

- ◆ "FMN" appears in place of "FM" when you select "ON" for the Menu No. 29 (FM NARROW) (page 39).
- ◆ Select "WFM" when you receive the audio signal of the broadcasting stations, such as FM or TV stations.
- ◆ If the Fine Tuning function is ON (page 35), you cannot select FM mode (FM/ NFM/ WFM). To select FM mode, turn the Fine Tuning function OFF.

BAR ANTENNA

Although the supplied wide-band helical antenna is used for receiving B-band frequencies, due to the size and length limitation, it may not be suitable for low HF band (below 10.1 MHz) reception. The transceiver features a built-in bar antenna for the reception frequency below 10.1 MHz. The transceiver automatically switches to the bar antenna when you select a frequency below 10.1 MHz for the B-band. However, you can connect an external antenna to the antenna connector instead.

To disable the built-in bar antenna below 10.1 MHz:

- 1 Press **[MNU]**.
- 2 Turn the **Tuning** control or press **[▲]/ [▼]** to select Menu No. 26 (BAR ANT).
- 3 Press **[▶]** or **[MNU]**.
- 4 Turn the **Tuning** control or press **[▲]/ [▼]** to select "DISABLED".
- 5 Press **[▶]** or **[MNU]** to store the setting.

Note: The bar antenna is embedded in the base of the transceiver, horizontally. The antenna has the same characteristics as a dipole antenna. If the target station's signal is weak, rotate the transceiver to find the best receiving position.

FINE TUNING

When you operate the B-band in LSB, USB, CW, or AM mode, you can turn the Fine Tuning function ON. You can further configure the Fine Tuning frequency step size from 33 Hz, 100 Hz (default), 500 Hz, or 1000 Hz.

Note: The Fine Tuning frequency step size reflects all available frequencies below 470 MHz for the B-band.

ACTIVATING FINE TUNING

To activate the Fine Tuning function:

- 1 Press **[VFO]**.
- 2 Select a frequency (below 470 MHz) on the B-band.
 - The operating mode must be LSB, USB, CW or AM.
- 3 Press **[FINE]**.
 - 100 Hz digit appears.

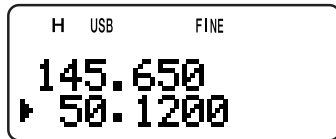

- 4 Turn the **Tuning** control or press **[▲]/[▼]** to tune to a station.

Note:

- ◆ The Fine Tuning function works only when you operate the frequency below 470 MHz.
- ◆ You cannot activate the Fine Tuning function on the A-band.
- ◆ The Fine Tuning function does not work in FM mode (FM/ WFM/ NFM).
- ◆ While in Fine Tuning mode, you cannot change the frequency step size (page 37), MHz mode (page 7), and MHz Scan (page 23).
- ◆ When you perform the Visual Scan (page 26) or direct frequency entry (excluding the same frequency band) (page 7), the transceiver exits Fine Tuning mode.
- ◆ Simply turning the Fine Tuning function OFF will not change the current frequency or display. However, when you change the frequency, the transceiver will use the currently selected frequency step size (page 37) and adjust the frequency accordingly, removing the transceiver from a finely tuned frequency.

■ Selecting a Fine Tuning Frequency Step

You can select Fine Tuning frequency step from 33 Hz, 100 Hz (default), 500 Hz, or 1000 Hz.

To select the Fine Tuning frequency step size:

- 1 Select a frequency on the B-band.
- 2 While the Fine Tuning mode is activated, press **[F]**, **[FINE]**.
 - The current frequency step size appears.

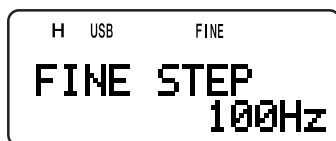

- 3 Turn the **Tuning** control or press **[▲]/[▼]** to select your desired frequency step from 33 Hz, 100 Hz (default), 500 Hz, or 1000 Hz.
- 4 Press **[▶]** or **[MNU]** to store the new setting.

APO (Auto Power OFF)

The transceiver switches OFF automatically if no keys or controls are pressed or adjusted, and no signal is received for 30 minutes (default). 1 minute before the transceiver switches OFF, warning beeps sound for a few seconds and "APO" blinks. Then, the transceiver turns OFF automatically. You can select the APO time from OFF (disable), 30 (default), and 60 minutes.

- 1 Press **[MNU]**.
- 2 Turn the **Tuning** control or press **[▲]/ [▼]** to select Menu No. 18 (APO).
- 3 Press **[▶]** or **[MNU]**.
- 4 Turn the **Tuning** control or press **[▲]/ [▼]** to select the APO time from OFF, 30, or 60 minutes.
- 5 Press **[▶]** or **[MNU]** to store the setting. Otherwise, press **[◀]** or **[PTT]** to cancel.

Note:

- ◆ The APO function does not work if the transceiver is scanning.
- ◆ When Tone Alert is ON, APO does not turn the power OFF.
- ◆ The APO timer starts counting down the time when no key presses, no control adjustments, and no command (SP/MIC jack) sequences are detected.
- ◆ The APO warning beep sounds even if Menu No. 19 (KEY BEEP) {page 37} is selected "OFF".

ATTENUATOR

The attenuator function is useful when extremely strong signals exist nearby your receiving frequency. When these type of signals are present, the receiver gain control may be erroneously controlled and overloaded by the strong signals, rather than by the target receiving signal. If this happens, the target receiving signal can be masked and buried by the strong signals. In this case, turn the Attenuator (approx. 20 dB) function ON. However, as a side effect, the target signal is also attenuated. You may have to adjust the **VOL** control to increase the audio output level when it is ON.

- 1 Press **[F]**, **[MONI]**.

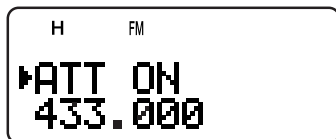

- "ATT ON" appears for 2 seconds on the display and the mode indicator starts blinking.
- 2 To turn the attenuator function OFF, press **[F]**, **[MONI]** again.
 - The mode indicator quits blinking.

Note:

- ◆ When the attenuator function is ON, both A and B-band, are attenuated. You cannot set the attenuator function independently for each band.
- ◆ "ATT ON" does not appear while scanning.

BATTERY LIFE

Before you operate the transceiver outside using a battery pack, it is important to know how long you can operate the transceiver. The following operating time is measured under the condition of TX: 6 seconds, RX: 6 seconds, and Stand-by: 48 seconds cycles. We recommend you carrying extra battery packs, in case the battery pack is discharged.

Battery Type	Output Power	Operating Time/Hours (Approx.)		
		2 m	1.25 m	70 cm
PB-42L (7.4 V)	H	6.5	6.0	6.0
	L	12.0	11.5	11.5
	EL	16.0	15.5	14.5
BT-13 (6.0 V)	H	5.0		
	L	6.0		
	EL	8.0		

BATTERY REMAINING

You can confirm the remaining battery capacity using this function. Confirm the battery type {below} prior to use this function. To check the remaining capacity:

- 1 Press **[F]**, **[LOW]**.

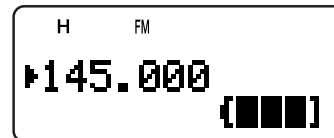

- The battery remaining indicator appears.
 - ▣▣▣▣ : High battery power
 - ▣▣▣ : Medium battery power
 - ▣▣ : Low battery power
 - ▣ : Needs recharging or replace the batteries

- 2 Press **[▶]** or **[MNU]** to exit the Battery remaining display mode.

Note: If you press **[F]**, **[LOW]** while charging, "CHARGE" or "STANDBY" appears {page 2}.

BATTERY TYPE

Before estimating the remaining battery capacity, set the battery type in Menu No. 30 (BATTERY) to the same type of battery that your are using (either Lithium or alkaline).

- 1 Press **[MNU]**.
- 2 Turn the **Tuning** control or press **[▲]/ [▼]** to select Menu No. 30 (BATTERY).
- 3 Press **[▶]** or **[MNU]**.
- 4 Turn the **Tuning** control or press **[▲]/ [▼]** to select the battery type from "LITHIUM" and "ALKALINE".
- 5 Press **[▶]** or **[MNU]** to store the setting. Otherwise, press **[◀]** or **[PTT]** to cancel.

Note: Use the PB-42L (Lithium battery pack) within the temperature range of $-10^{\circ}\text{C} \sim 50^{\circ}\text{C}$ ($14^{\circ}\text{F} \sim 122^{\circ}\text{F}$).

BATTERY SAVER

Battery Saver extends the operating time of the transceiver. It automatically activates when the squelch is closed and no key is pressed for more than 10 seconds. To reduce the battery consumption, it shuts the receiver circuit OFF for the programmed time then momentarily turn it back ON to detect a signal. To program the receiver shut-off period for the battery saver:

- 1 Press **[MNU]**.
- 2 Turn the **Tuning** control or press **[▲]/ [▼]** to select Menu No. 17 (BAT SAVER).
- 3 Press **[▶]** or **[MNU]**.
- 4 Turn the **Tuning** control or press **[▲]/ [▼]** to select the receiver shut-off period from OFF, 0.2, 0.4, 0.6, 0.8, 1.0 (default), 2.0, 3.0, 4.0, and 5.0 seconds.
- 5 Press **[▶]** or **[MNU]** to store the setting. Otherwise, press **[◀]** or **[PTT]** to cancel.

Note:

- ◆ The longer the period, the more you can save the battery consumption. However, there is a greater chance of missing a signal.
- ◆ When the **DC IN** jack is used, the Battery Saver function is automatically turned OFF.
- ◆ The Battery Saver function does not work while scanning.
- ◆ The Battery Saver function does not work in USB/ LSB/ CW.

BEAT SHIFT

Since the transceiver uses a microprocessor to control various functions of the transceiver, the CPU clock oscillator's harmonics or image may appear on some spots of the receiving frequencies. In this case, turn the Beat Shift function ON.

- 1 Press **[MNU]**.
- 2 Turn the **Tuning** control or press **[▲]/ [▼]** to select Menu No. 25 (BEAT SHIFT).
- 3 Press **[▶]** or **[MNU]**.
- 4 Turn the **Tuning** control or press **[▲]/ [▼]** to select "ON".
- 5 Press **[▶]** or **[MNU]** to store the setting. Otherwise, press **[◀]** or **[PTT]** to cancel.

BEEP FUNCTION

The Beep function provides you confirmation of entry, error status, and malfunctions of the transceiver. We recommend you leave it ON in order to detect erroneous operations and malfunctions.

However, to turn the beep function OFF:

- 1 Press **[MNU]**.
- 2 Turn the **Tuning** control or press **[▲]/ [▼]** to select Menu No. 19 (KEY BEEP).
- 3 Press **[▶]** or **[MNU]**.
- 4 Turn the **Tuning** control or press **[▲]/ [▼]** to select "OFF".
- 5 Press **[▶]** or **[MNU]** to store the setting. Otherwise, press **[◀]** or **[PTT]** to cancel.

The transceiver generates the following warning beeps even if the beep function is turned OFF.

- APO warning beeps {page 36}
- DC voltage error {page 2}
- PLL circuit malfunctions
- Time-Out timer warning beep {page 40}

Note: The beep output level is linked to the **VOL** control position.

DISPLAY CONTRAST

You can adjust the LCD contrast level from 1 (weakest) to 16 (strongest) by accessing Menu No. 16 (CONTRAST). The default level is 8.

- 1 Press **[MNU]**.
- 2 Turn the **Tuning** control or press **[▲]/ [▼]** to select Menu No. 16 (CONTRAST).
- 3 Press **[▶]** or **[MNU]**.
- 4 Turn the **Tuning** control or press **[▲]/ [▼]** to adjust the LCD contrast.



- The relative contrast level appears on the bar-graph.
- 5 Press **[▶]** or **[MNU]** to store the setting. Otherwise, press **[◀]** or **[PTT]** to cancel.

Note: If you continuously transmit or leave the transceiver sitting in a hot atmosphere, the background of the LCD display may turn grey and the contrast will become reduced. In this case, turn the transceiver OFF or let the transceiver cool down for a while. After the transceiver cools down, the LCD display returns normal.

FREQUENCY STEP SIZE

Choosing the correct frequency step size is essential in order to select your exact receive frequency using the **Tuning** control or pressing **[▲]/ [▼]**. You can select your desired frequency step size from:

5 kHz, 6.25 kHz, 8.33 kHz (Air band only), 9 kHz (AM band only), 10 kHz, 12.5 kHz, 15 kHz, 20 kHz, 25 kHz, 30 kHz, 50 kHz, 100 kHz.

Note: 5 kHz, 6.25 kHz, and 15 kHz step size cannot be used on the frequency above 470 MHz.

11 OPERATOR CONVENIENCES

The default step size for the amateur radio bands are as follows.

Band	Amateur Radio Band	TH-F6A	TH-F7E
A-band	2 m	5 kHz	12.5 kHz
	1.25 m	20 kHz	—
	70 cm	25 kHz	25 kHz
B-band	2 m	5 kHz	12.5 kHz
	1.25 m	20 kHz	12.5 kHz
	70 cm	25 kHz	25 kHz
	23 cm	25 kHz	25 kHz

For the B-band, refer to pages 33 and 34 for the default frequency step size in the various frequency bands. The transceiver stores the frequency step size parameter for each band independently. You can also further fine tune the frequency in LSB, USB, AM, and CW modes on the B-band {page 34}.

To change the frequency step size:

- Press **[F]**, **[FINE]**.
 - The current frequency step size appears.
- Turn the **Tuning** control or press **[▲]/ [▼]** to select your desired frequency step size.
- Press **[▶]** or **[MNU]** to store the setting. Otherwise, press **[◀]** or **[PTT]** to cancel.

Note: If you change to a frequency step size that does not match the current operating frequency, the transceiver automatically adjusts the frequency to match the new frequency step size.

LAMP

To illuminate the transceiver:

Press **[LAMP]**.

- Approximately 5 seconds after releasing **[LAMP]**, the light goes OFF if no other key is pressed.
- Pressing any key, including **[PTT]** other than **[LAMP]** while the display is lit, restarts the 5-second timer.
- Pressing **[LAMP]** turns the light OFF immediately.

To keep the light ON continuously:

Press **[F]**, **[LAMP]**.

- The light remains ON until you press **[F]**, **[LAMP]** again.

LOCK FUNCTION

The lock function disables most of the keys to prevent you from accidentally activating a function.

- Press **[F]** (1 s).

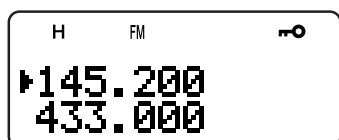

- "**ⓧ**" appears when this function is ON.

- The following keys cannot be locked:
[LAMP], **[MONI]**, **[SQL]**, **[PTT]**, **[F]** (1 s), **[ⓧ]** (POWER) and **[F]** then **[LAMP]**.

- Press **[F]** (1 s) to unlock the keys.

Note:

- The **Tuning** control is also locked. To unlock the **Tuning** control while the Lock function is ON, access Menu No. 7 (TUNE ENABLE) and select "ON".
- You cannot perform the Microprocessor reset {page 50} while the Lock function is ON.
- Microphone PF keys {below} work even if the Lock function is ON.

TUNE ENABLE

Even if the Lock function is ON, you sometimes may want to turn the **Tuning** control to change the frequency. In this case, turn the Tune Enable function ON.

- Press **[MNU]**.
- Turn the **Tuning** control or press **[▲]/ [▼]** to select Menu No. 7 (TUNE ENABLE).
- Press **[▶]** or **[MNU]**.
- Turn the **Tuning** control or press **[▲]/ [▼]** to select "ON".
- Press **[▶]** or **[MNU]** to store the setting. Otherwise, press **[◀]** or **[PTT]** to cancel.

MICROPHONE PF KEYS (OPTIONAL)

If you have an optional SMC-33 or SMC-34 speaker microphone, you can access many transceiver settings without using transceiver keys or controls. The 1, 2, and 3 keys located on the top of the microphone are programmable with the transceiver key (or key combination) functions. The default assignments are as follows.

Mic [1]: **A/B**

Mic [2]: **VFO/ MR**

Mic [3]: **CALL** (TH-F6A)/ **1750 Hz** (TH-F7E)

Note:

- Turn the transceiver OFF before connecting the optional speaker microphone.
- If the LOCK switch on the rear of the microphone is ON, you must move the switch to the OFF position to program the keys.

- Press one of the following key combinations to re-program the keys on the speaker microphone.
 - Press Mic [1]+**[ⓧ]** (POWER) to re-program Mic [1]
 - Press Mic [2]+**[ⓧ]** (POWER) to re-program Mic [2]
 - Press Mic [3]+**[ⓧ]** (POWER) to re-program Mic [3]

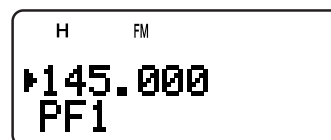

- Press a key or key combination you want to assign to the function key.

[KEY]	
LAMP	REV
MONI	MN<->f
LOW	MHz
BAND	FINE
A/B	VFO
INFO	MR
SQL	CALL ³
BAL	1750 Hz ³
TONE	▲/▼ ¹
MNU	◀/▶

[F] + [KEY]	
LAMP ²	MN.IN
BATT	L.OUT
MODE	STEP
DUAL	
VISUAL	M>V
VOX	M.IN
PRI	C.IN
T.SEL	ATT
SHIFT	

¹ Tuning control (Up or Down) can be also programmed.
² The light stays ON until you press the key again (above).
³ Both keys cannot be assigned to the PF keys at the same time (TH-F7E only).

You can also press [PTT] to assign a function key to alternate VFO and Memory Recall mode.

MONITOR

When you are receiving while the squelch function is ON, weak signals may become intermittent.

Or, if the CTCSS or DCS function is ON, you may want to disable the squelch function temporarily to monitor the current channel activities.

In these cases, use the Monitor function to disable the squelch function temporarily.

To activate the Monitor function:

- 1 Press and hold [MONI].
 - The speaker is unmuted and you can monitor the signals.
- 2 Release [MONI] key to return to normal operation.

NARROW BAND FM OPERATION

By default, if you select FM mode, the transceiver operates in normal FM deviation (±5 kHz) mode for both transmission and reception. You can also operate the transceiver in narrow band FM deviation (±2.5 kHz) mode on 2 m, 1.25 m (TH-F6A only), and 70 cm bands for both A and B-bands. To operate the transceiver in narrow band FM:

- 1 Press [MNU].
- 2 Turn the Tuning control or press [▲]/ [▼] to select Menu No. 29 (FM NARROW).
- 3 Press [▶] or [MNU].
- 4 Turn the Tuning control or press [▲]/ [▼] to select "ON".
- 5 Press [▶] or [MNU] to store the setting. Otherwise, press [◀] or [PTT] to cancel.

When narrow band FM operation is ON, "FMN" appears instead of "FM".

Note:

- ◆ When you select "9600" bps for the Menu No. 28 (PACKET) , the operating mode temporarily returns to a normal FM mode.
- ◆ You can store the narrow band FM operation status to each amateur radio band.

POWER-ON MESSAGE

You can change the greeting message (a maximum of 8 characters) when the transceiver is turned ON.

- 1 Press [MNU].
- 2 Turn the Tuning control or press [▲]/ [▼] to select Menu No. 15 (PWR-ON MSG).
- 3 Press [▶] or [MNU].
 - The current message and entry cursor appear.



- 4 Turn the Tuning control or press [▲]/ [▼] to select the first character.
 - You can enter alphanumeric characters plus special ASCII characters. Refer to the table on page 17 for the available characters.
 - For other method of selecting characters, refer to "NAMING A MEMORY CHANNEL" step 3 on page 17.
- 5 Press [▶].
 - The cursor moves to the next digit.
- 6 Repeat steps 4 and 5 to enter up to 8 digits.
 - Pressing [▶] after selecting the 8th digit completes the programming.
 - To complete programming before entering the characters less than 8 digits, press [MNU] or [▶] twice. To cancel, press [◀] or [PTT].
 - Press [◀] to move the cursor backward.

PROGRAMMABLE VFO

If you want to limit the operating frequencies within a certain range, program the upper and lower frequency limits to the program VFO parameters. For example, if you select 144 MHz for the lower limit and 145 MHz for the upper limit, the tunable range will be limited from 144.000 MHz to 145.995 MHz.

- 1 Press [A/B] to select the A-band.
- 2 Press [VFO].
- 3 Press [BAND] until you select the desired amateur radio band to configure the programmable VFO frequency range.
- 4 Press [MNU].
- 5 Turn the Tuning control or press [▲]/ [▼] to select Menu No. 4 (PROG VFO).

11 OPERATOR CONVENIENCES

- The current programmable frequency range for the band appears.

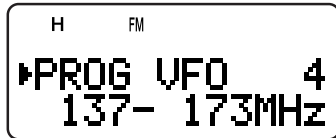

- 6 Press **[>]** or **[MNU]**.
- 7 Turn the **Tuning** control or press **[▲]/ [▼]** to select the lower limit frequency in MHz.
- 8 Press **[>]** or **[MNU]** to store the lower limit frequency. To cancel, press **[<]** or **[PTT]**.
 - The cursor moves to the right and the upper limit frequency blinks.
- 9 Turn the **Tuning** control or press **[▲]/ [▼]** to select the upper limit frequency in MHz.
- 10 Press **[>]** or **[MNU]** to store the upper limit frequency. To cancel, press **[<]** or **[PTT]**.

Note:

- ◆ Programmable VFO is available only for A-band.
- ◆ You cannot program the 100 kHz or lower digits.
- ◆ The upper limit frequency cannot be selected lower than the selected lower limit frequency.

SINGLE BAND OPERATION

If you do not want to use the A and B-band receivers at the same time, you can turn the A or B-band receiver OFF.

- 1 Press **[A/B]** to select the band you want to operate.
- 2 Press **[F]**, **[A/B]**.
 - The frequency of the selected band appears in large font and the other band receiver is turned OFF and muted.
 - You can also press **[A/B]** to alternate the A and B-band.

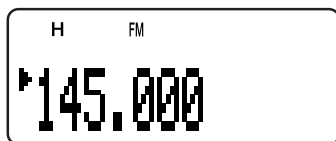

- 3 To return to normal dual-band operation, press **[F]**, **[A/B]** again.

TIME-OUT TIMER

The Time-out Timer limits the time of each transmission. The built-in time-out timer limits each transmission time to a maximum of 10 minutes. Just before the transceiver stops the transmission, a warning beep sounds. It is necessary to protect the transceiver from thermal damage. You cannot turn this function OFF.

Note: A warning beep sounds even if you select Menu No. 19 (KEY BEEP) OFF.

TONE ALERT

Tone Alert provides an audible alarm when signals are received on the frequency you are monitoring. In addition, it shows the number of hours and minutes elapsed after signals have been received. If you use Tone Alert with CTCSS or DCS, it sounds only when a received CTCSS tone or DCS code matches the tone or code you selected.

- 1 Select your desired frequency or memory channel.
- 2 Press **[F]**, **[ENT]**.
 - “🔔” icon appears.

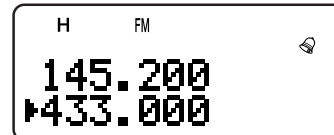

- When a signal is received, an alarm sounds for 10 seconds and “🔔” icon starts blinking.



- Press **[PTT]** while “🔔” icon is blinking to turn the Tone Alert function OFF.
- When 99 hours and 59 minutes pass after a signal has been received, counting stops.
- Each time a new signal is received, the elapsed time resets to 00:00.

Note:

- ◆ While Tone Alert is ON, there is no speaker output when a signal is received. To monitor the signal, press and hold **[MONI]**.
- ◆ When Tone Alert is ON, APO does not turn the power OFF.
- ◆ If you switch the transceiver OFF while “🔔” icon is blinking, the transceiver does not back the elapsed time.
- ◆ When Tone Alert is ON, you can use only the following functions: **[LAMP]**, **[MONI]**, **[SQL]**, **[A/B]**, **[F]** then **[LAMP]**, and **[F]** then **[ENT]**.

TX INHIBIT

You can inhibit the transmission to prevent unauthorized individuals from transmitting, or to eliminate accidental transmissions while carrying the transceiver.

- 1 Press **[MNU]**.
- 2 Turn the **Tuning** control or press **[▲]/ [▼]** to select Menu No. 8 (TX INHIBIT).
- 3 Press **[>]** or **[MNU]**.
- 4 Turn the **Tuning** control or press **[▲]/ [▼]** to select “ON”.
- 5 Press **[>]** or **[MNU]** to store the setting. Otherwise, press **[<]** or **[PTT]** to cancel.
 - “TX INHIBIT!” appears and an error beep sounds if you press **[PTT]** while TX Inhibit is activated.

TX POWER

To change the transmission output power:

Press [LOW].

- Each time you press [LOW], the icon cycles from H → L → EL, and then goes back to H.

The output power varies depending on the battery type and operating voltage. The table below shows the approximate output power when the transceiver operates with different types of battery or DC power source.

Battery Type	Output Power Selection	Output Power (Approx.)
		TH-F6A/ TH-F7E
BT-14 (6.0 V)	H	0.5 W
	L	0.3 W
	EL	0.05 W
PB-42L (7.4 V)	H	5.0 W
	L	0.5 W
	EL	0.05 W
DC IN (13.8 V)	H	5.0 W
	L	2.0 W
	EL	0.5 W

Note:

- You can store the TX Power settings independently for A and B-band.
- If the DC IN voltage exceeds 14.5 V DC and "H" (High Power) is selected, "H" icon blinks and the output power is reduced to "L" level (Low Power) automatically.

VOLUME BALANCE

While you are receiving on the A and B-bands at the same time, you may sometimes feel that the audio output on either band is too loud. You can adjust the volume balance level of the bands.

1 Press [BAL].

- The balance scale and blinking cursor appear.

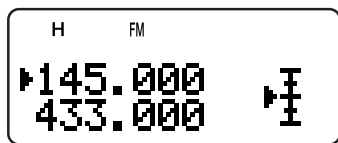

2 Turn the Tuning control or press [▲]/ [▼] to change the volume balance level of the bands.

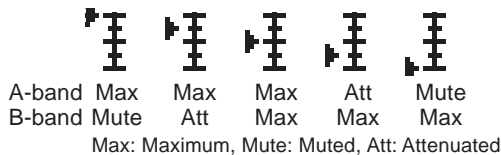

3 Press [▶] or [MNU] to store the setting. Otherwise, press [◀] to cancel without changing the current settings.

Note:

- If TNC is selected for Menu No. 9 (SP/MIC JACK), the squelch status (REM/ SQ) changes based on your volume balance settings (pages 45, 46).

- You can also set the volume balance while in Single Band Operation (page 40).

VOX (VOICE-OPERATED TRANSMIT)

VOX eliminates the necessity of manually switching to the transmit mode each time you want to transmit. The transceiver automatically switches to transmit mode when the VOX circuitry senses that you have begun speaking into the microphone.

When you operate the VOX function, you must use an optional accessory, HMC-3 or KHS-21. Because both the internal speaker and microphone are too near to be used for the VOX function.

To turn the VOX function ON:

Press [F], [SQL].

- "VOX" appears.

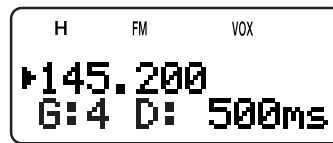

- To exit VOX mode, press [F], [SQL] again.

Note:

- You cannot turn the VOX function ON while the Visual Scan (pages 26, 27) is activated.
- While the VOX function is ON, the Menu No. 28 (PACKET) settings return to 1200 bps (page 45).
- While the VOX function is ON, you cannot use [▲]/[▼]/[◀]/[▶] to adjust other settings, such as the frequency and operating band.
- While in the Menu mode (page 9), the VOX function is disabled temporarily.
- Since the VOX circuit must detect the presence of your voice, you may notice a slight delay in transmission. The very first part of your message may not be transmitted.
- Turn the HMC-3's VOX function OFF when you use the internal VOX function.

VOX GAIN

To enjoy the VOX function, take the time to properly adjust the VOX Gain. This level controls the VOX circuit to detect the presence or absence of your voice. There are 2 ways of adjusting the VOX Gain.

When the VOX function is already ON:

1 Press [▲]/ [▼] to select the desired VOX Gain from 0 (least sensitive) to 9 (most sensitive).

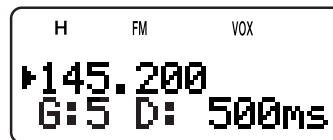

- The VOX Gain level numbers, "G: 4" changes accordingly (default is 4).
- 2 While speaking into the microphone using your normal tone of voice, adjust the VOX Gain by pressing [▲]/ [▼] until the transceiver reliably switches to transmit mode each time you speak.
- The setting should not allow background noise to switch the transceiver to transmit mode.

11 OPERATOR CONVENIENCES

From the Menu:

- 1 Press **[MNU]**.
- 2 Turn the **Tuning** control or press **[▲]/ [▼]** to select Menu No. 21 (VOX GAIN).
- 3 Press **[▶]** or **[MNU]**.
- 4 Turn the **Tuning** control or press **[▲]/ [▼]** to select the desired VOX Gain (default is 4).

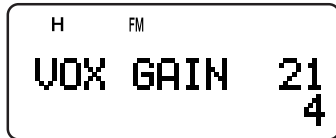

- The selectable gain range is from 0 (least sensitive) to 9 (most sensitive).
 - The setting should not allow background noise to switch the transceiver to transmit mode.
- 5 Press **[▶]** or **[MNU]** to store the setting. Otherwise, press **[◀]** or **[PTT]** to cancel.

VOX DELAY TIME

If the transceiver returns to receive mode too quickly after you stop speaking, your final word may not be transmitted. To avoid this, select an appropriate delay time that allows all of your words to be transmitted. However, do not make the delay overly long. There are 2 ways of adjusting the VOX Delay Time.

When the VOX function is already ON:

Press **[◀]/ [▶]** to select the desired delay time from 250, 500 (default), 750, 1000, 1500, 2000 and 3000 ms.

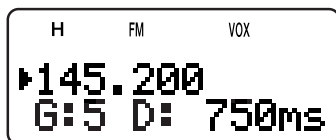

- The VOX Delay Time, "D: 500ms" changes accordingly.

From the Menu:

- 1 Press **[MNU]**.
- 2 Turn the **Tuning** control or press **[▲]/ [▼]** to select Menu No. 22 (VOX DELAY).
- 3 Press **[▶]** or **[MNU]**.
- 4 Turn the **Tuning** control or press **[▲]/ [▼]** to select the desired delay time from 250, 500 (default), 750, 1000, 1500, 2000 and 3000 ms.



- 5 Press **[▶]** or **[MNU]** to store the setting. Otherwise, press **[◀]** or **[PTT]** to cancel.

Note:

- ◆ If you press **[PTT]** while the VOX function is ON, the VOX Delay Time is not reflected to the transmission.
- ◆ If you press **[CALL]** (if 1750 Hz is programmed) (page 13) to transmit 1750 Hz tone, the VOX Delay Time is not reflected.
- ◆ If the DCS function (page 29) is ON, the transceiver remains in the transmission mode for the VOX Delay Time, then it sends "Turn-Off Code" to close the receiving parties squelch.

VOX ON BUSY

You can configure the transceiver to force VOX transmission even if the transceiver is receiving a signal on A or B-band.

- 1 Press **[MNU]**.
- 2 Turn the **Tuning** control or press **[▲]/ [▼]** to select Menu No. 20 (VOXonBUSY).
- 3 Press **[▶]** or **[MNU]**.
- 4 Turn the **Tuning** control or press **[▲]/ [▼]** to select "ON".

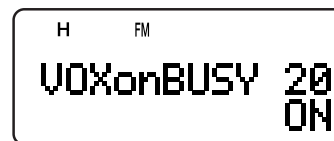

- To suppress the VOX transmission when the transceiver is receiving a signal, select "OFF".
- 5 Press **[▶]** or **[MNU]** to store the setting. Otherwise, press **[◀]** or **[PTT]** to cancel.

Note: You can press **[PTT]** or **[CALL]** (if 1750 Hz is programmed) to transmit, regardless of Menu No. 20 (VOXonBUSY) settings.

WIRELESS REMOTE CONTROL (TH-F6A ONLY)

If you also have a **KENWOOD** multi-band mobile transceiver, you can control one of its bands by sending DTMF tones from this portable transceiver. You will find this function useful when you want to control your mobile transceiver from a location outside your vehicle.

Note:

- ◆ You can remotely control only mobile transceivers that have both the DTSS and Remote Control functions.
- ◆ The FCC rules permit you to send control codes only on the 70 cm band.

PREPARATION

Let us assume the 2 m band of the mobile transceiver will be controlled.

On the portable transceiver:

- 1 Press **[PTT]+[VFO]+[ϕ]** (POWER).
 - The current secret access code number appears. The default is 000.



- 2 Press a numeric key (0 to 9) to enter a 3-digit secret number.
 - You can also turn the **Tuning** control or press **[▲]/[▼]** to select each digit. Press **[▶]** (or **[◀]**) to move the cursor to the next (or previous) digit.
- 3 When the cursor is at the right most position, press **[▶]** to complete the setting.
- 4 Press **[BAND]** to select the 70 cm band.
- 5 Turn the **Tuning** control to select the transmit frequency.
- 6 Turn a transceiver power OFF.
- 7 Press **[PTT]+[MR]+[ϕ]** (POWER).
 - The transceiver enters Remote Control mode. "MOBILE CTRL" appears.

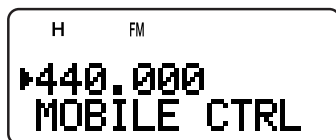

- To exit Remote Control mode, repeat steps 6 and 7.

On the mobile transceiver:

- 8 Program the DTSS code on the 70 cm band as the secret number.
 - Select the same number as you selected in step 2.
 - For the programming method, refer to the instruction manual of the mobile transceiver.
- 9 Select the receive frequency on the 70 cm band.
 - Mate this frequency with the transmit frequency on the portable transceiver.

10 Make the transceiver enter Remote Control mode.

- For the method, refer to the instruction manual of the mobile transceiver.

CONTROL OPERATION

When in the Remote Control mode, the keys of the transceiver will function as below. Each time you press a key, the transceiver will automatically enter transmit mode and send the corresponding command to the mobile transceiver.

1	2	3	A
REV ON ¹	TONE ON	CTCSS ON	ENT
4	5	6	B
REV OFF ¹	TONE OFF	CTCSS OFF	TONE SEL
7	8	9	C
CALL	VFO	MR	(REP ON) ²
*	0	#	D
DOWN	LOW	UP	(REP OFF) ²

¹ TM-V7A/ TM-D700A: REV ON/ OFF
TS-2000/ TS-B2000: DCS ON/ OFF

Other mobile transceiver: TONE ALERT ON/ OFF

² Switches Repeater function ON/ OFF if the mobile transceiver supports this function.

To change the transmit/ receive frequency:

[VFO] → [ENT] → [0] ~ [9] (enter the necessary digits) **→ [ENT]**

Or

[VFO] → [UP]/ [DOWN]

To recall a memory channel:

[MR] → [ENT] → [0] ~ [9] (enter the necessary digits) **→ [ENT]**

Or

[MR] → [UP]/ [DOWN]

To change the tone (or CTCSS) frequency:

[TONE SEL] → [0] ~ [9] (enter 2 digits; ex. **[0], [5]**) **→ [TONE SEL]**

- Refer to the Tone frequency table on your mobile transceiver for the Tone number.
- Your mobile transceiver may require you to first activate the Tone or CTCSS function. It may also allow you to program a separate tone and CTCSS frequency. Refer to the instruction manual of the mobile transceiver.

OPTIONAL ACCESSORIES

BT-13

Battery Case (4 AA/ LR6)



EMC-3

Clip Microphone with Earphone



HMC-3

Headset (with VOX/ PTT)



KHS-21

Headset



PB-42L

Li-ion Battery Pack (7.4 V, 1550 mAh)



PG-2W

DC Power Cable



PG-3J

Cigarette Lighter Power Cable



SMC-32

Speaker Microphone Cable



SMC-33

Speaker Microphone (with PF keys)



SMC-34

Speaker Microphone (with PF keys and VOL control)



SP/MIC JACK

The SP/MIC jack on the transceiver can be configured to interface to various kind of the peripherals available for the transceiver, such as a speaker microphone (SMC-32/ 33/ 34), PC interface cable and a TNC. Access Menu No. 9 (SP/MIC JACK) and select the peripheral type from “SP/MIC”, “TNC”, and “PC”.

You can further configure the transceiver to interface to a high speed (9600 bps) TNC that requires a direct FM modulation {below}.

SELECTING SP/MIC JACK FUNCTION

Unless you connect the transceiver to a TNC or PC, the default setting of the SP/MIC jack function (Menu No. 9), “SP/MIC” works fine. However, if you want to interface to a different type of peripheral, configure the SP/MIC jack function:

- 1 Press **[MNU]** to enter Menu mode.
- 2 Turn the **Tuning** control or press **[▲]/ [▼]** to select Menu No. 9 (SP/MIC JACK).
- 3 Press **[▶]** or **[MNU]**.
- 4 Turn the **Tuning** control or press **[▲]/ [▼]** to select the appropriate peripheral type from “SP/MIC” (default), “TNC”, and “PC”.

SP/MIC Function	Peripheral Type
SP/MIC	Speaker microphone, headset, earphone, TNC without a squelch status support
TNC	TNC with a squelch status support
PC	PC with the memory channel control software for the transceiver

- 5 Press **[▶]** or **[MNU]** to store the setting. Otherwise, press **[◀]** or **[PTT]** to cancel.
 - If necessary, configure and select the additional settings.
- 6 Press **[ϕ]** (POWER) to turn the transceiver OFF.
- 7 Connect a peripheral to the SP/MIC jack.
- 8 Press **[ϕ]** (POWER) to turn the transceiver ON.

SP/MIC

If you plug the speaker microphone or headset into the SP/MIC jack, access Menu No. 9 and select “SP/MIC” (default). To emulate the programmable function keys using external keys in order to control the transceiver, refer to the circuit diagram below {page 38}.

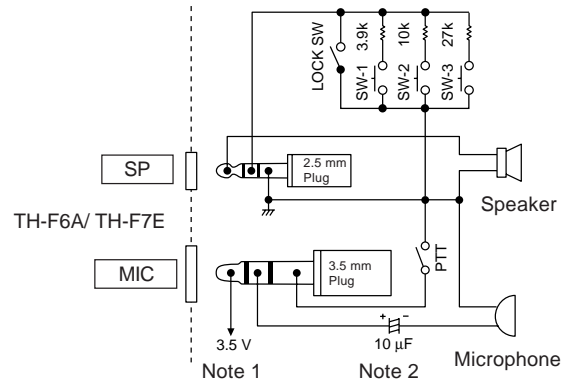

Note 1:

Voltage is developed across a 100Ω resistor on the 3.5 V line in the transceiver. When 2 mA flows, approximately 3.3 V is developed.

Note 2:

A 10 µF capacitor is not required in the following cases.

- When other equipment has DC blocking capacitors.
- When a 2-terminal electret condenser microphone is used.

TNC

If you want to utilize the squelch status on your TNC, access Menu No. 9 and select “TNC”. From the TNC, make the interface cable that connects to SP/PRD, MIC/PKD, PTT, REM/SQ, and GND on the transceiver SP/MIC jack terminal. In addition, if your TNC supports 9600 bps packet (G3RUH/ GMSK 9600 bps modem), access Menu No. 28 (PACKET) and select “9600” bps. This option allows you to transmit/ receive packet signals in a direct FM modulation/ quadrature detector output. You must use the A-band to transmit and receive 9600 bps packet signal. The following diagram shows the available terminals on the SP/MIC jack for the TNC.

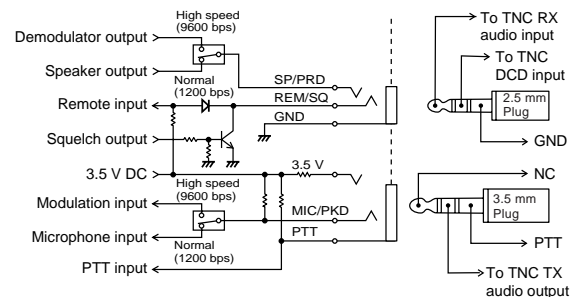

Note:





- ◆ When you select 9600 bps for Menu No. 28 (PACKET), you cannot monitor the sound from the speaker. Select 1200 bps for Menu No. 28 (PACKET) when you return to normal operation.
- ◆ While the VOX function is turned ON, Menu No. 28 (PACKET) returns to 1200 bps {page 41}.

14 INTERFACING TO PERIPHERALS

Since the transceiver can receive 2 different frequencies, it outputs the squelch status (REM/SQ) as shown the table below.

Note: Contact an authorized dealer for the PC Interface cable availability.

Press **[BAL]** to set the Volume balance {page 41}.

VOL Balance	REM/SQ Sensing Band
	A-band
	A-band and/or B-band (logic sum)
	
	
	B-band

■ PC

If you want to connect the transceiver to a PC in order to manage the memory channels in the transceiver, you need an interface cable. You will also need the supported software to download, upload, and edit the memory channel contents of the transceiver.

To manage the memory contents in the transceiver from a PC, access Menu No. 9 and select "PC".

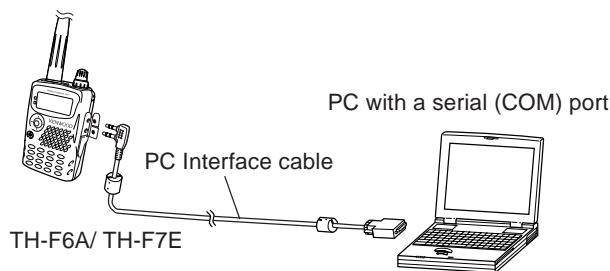

For your information, the following diagram shows how the TH-F6A/ TH-F7E communicates to the PC using a serial (COM) port.

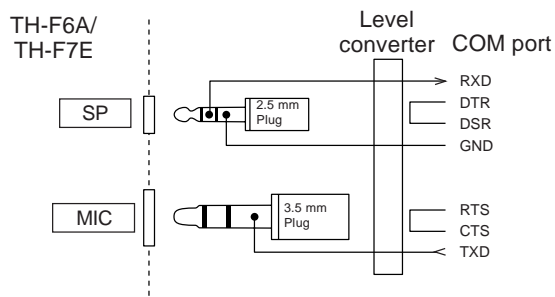

GENERAL INFORMATION

Your transceiver has been factory aligned and tested to specification before shipment. Under normal circumstances, the transceiver will operate in accordance with these operating instructions. All adjustable trimmers, coils and resistors in the transceiver were preset at the factory. They should only be readjusted by a qualified technician who is familiar with this transceiver and has the necessary test equipment. Attempting service or alignment without factory authorization can void the transceiver warranty.

When operated properly, the transceiver will provide years of service and enjoyment without requiring further realignment. The information in this section gives some general service procedures requiring little or no test equipment.

SERVICE

If it is ever necessary to return the equipment to your dealer or service center for repair, pack the transceiver in its original box and packing material. Include a full description of the problems experienced. Include your telephone number, fax number, and email address (if available) along with your name and address in case the service technician needs to contact you for further explanation while investigating your problem. Do not return accessory items unless you feel they are directly related to the service problem.

You may return your transceiver for service to the authorized **KENWOOD** dealer from whom you purchased it or any authorized **KENWOOD** service center. A copy of the service report will be returned with the transceiver. Please do not send subassemblies or printed circuit boards. Send the complete transceiver.

Tag all returned items with your name and call sign for identification. Please mention the model and serial number of the transceiver in any communication regarding the problem.

SERVICE NOTE

If you desire to correspond on a technical or operational problem, please make your note short, complete, and to the point. Help us help you by providing the following:

- 1 Model and serial number of equipment.
- 2 Question or problem you are having.
- 3 Other equipment in your station pertaining to the problem.
- 4 Meter readings.
- 5 Other related information (menu setup, mode, frequency, key sequence to induce malfunction, etc).



CAUTION

DO NOT PACK THE EQUIPMENT IN CRUSHED NEWSPAPERS FOR SHIPMENT! EXTENSIVE DAMAGE MAY RESULT DURING ROUGH HANDLING OR SHIPPING.

Note:

- ◆ Record the date of purchase, serial number and dealer from whom the transceiver was purchased.
- ◆ For your own information, retain a written record of any maintenance performed on the transceiver.
- ◆ When claiming warranty service, please include a photocopy of the bill of sale, or other proof-of-purchase showing the date of sale.

CLEANING

The keys, controls, and case of the transceiver are likely to become soiled after extended use. Remove the controls from the transceiver and clean them with a neutral detergent and warm water. Use a neutral detergent (no strong chemicals) and a damp cloth to clean the case.

BACKUP BATTERY

This transceiver uses an EEPROM to store memory channel data, menu configurations, and all necessary operation parameters. So, you never have to worry about replacing back-up batteries to operate the transceiver.

15 TROUBLESHOOTING

TROUBLESHOOTING

The problems described in the following table are commonly encountered operational malfunctions. These types of difficulties are usually caused by improper hook-up, accidental incorrect control settings, or operator error due to incomplete programming. These problems are usually not caused by circuit failure. Please review this table, and the appropriate section(s) of this instruction manual, before assuming your transceiver is defective.

Note: Placing powered PC peripherals near this transceiver may cause noise in the transceiver.

Problem	Probable Cause	Corrective Action	Ref. Page
Nothing appears on the display when the transceiver is switched ON, or the display is blinking ON and OFF.	1 The battery pack is discharged.	1 Recharge the battery pack or replace the batteries.	2
	2 The protection circuit for the Li-ion battery pack is activated.	2 Release the Li-ion battery pack once, then recharge the battery pack.	2
	3 If using the optional DC cable: a) Bad power cable or connections b) Open (blown) power supply fuse	3 a) Check the power cable and connections, then correct/replace as necessary. b) Investigate the cause for the open fuse. Replace the fuse.	2 2
Most keys and the Tuning control do not function.	1 Transceiver Lock is ON (the "⊞" icon is visible).	1 Press [F] (1 s) to switch OFF Transceiver Lock.	38
	2 The transceiver is in Channel Display mode.	2 Press [A/B]+[ϕ] (POWER) to exit Channel Display mode.	21
	3 Tone Alert is ON (the "🔊" icon is visible).	3 Press [F], [ENT] to switch OFF Tone Alert.	40
You cannot select the exact desired frequency using [▲]/[▼] or the Tuning control.	1 The current frequency step size does not allow the frequency to be selected.	1 Press [F], [FINE] to select an appropriate frequency step size.	37
	2 The Fine Tuning function is not activated.	2 Press [FINE] to activate the Fine Tuning function.	35
	3 The Fine Tuning frequency step size is wrong.	3 While the Fine Tuning function is ON, press [F], [FINE] to select an appropriate Fine Tuning frequency steps size.	35
	4 Programmable VFO frequency range is programmed.	4 Access Menu No. 4 (PROG VFO) to expand the frequency range.	39
You cannot recall any memory channels.	1 You have stored no data in any of the memory channels using the current band.	1 Store the desired frequencies in memory channels using the current band.	15
	2 "CURRENT BAND" is selected for Menu No. 3 (MR METHOD).	2 Access Menu No. 3 (MR METHOD) and select "ALL BANDS".	16
The receiving sound volume is weak even if the signal is strong.	1 Attenuator function is ON.	1 Press [F], [MONI] to turn the Attenuator function OFF.	36
	2 The receiving station may be operating in narrow band FM bandwidth.	2 Access Menu No. 29 (FM NARROW) and select "ON".	39
Turning the VOL control does not allow you to hear audio.	1 The speaker for the band you want to monitor is muted.	1 Press [BAL] , then turn the Tuning control to adjust the volume balance between A and B-bands.	41
	2 The 9600 bps is selected for Menu No. 28 (PACKET)	2 Select 1200 bps for Menu No. 28 (PACKET).	45
You cannot transmit by pressing the PTT switch.	1 You selected a frequency outside the allowable range.	1 Select a frequency within the allowable transmit frequency range.	7, 53
	2 You selected a transmit offset that places the transmit frequency outside the limit.	2 Press [F], [REV] repeatedly so neither "+" nor "-" is visible.	12
	3 TX Inhibit is ON.	3 Access Menu No. 8 (TX INHIBIT) and select "OFF".	40
	4 Tone Alert is ON.	4 Press [F], [ENT] to switch OFF Tone Alert.	40
	5 The battery pack voltage is too low to transmit.	5 Charge or replace the battery pack.	2, 36

15 TROUBLESHOOTING

Problem	Probable Cause	Corrective Action	Ref. Page
Repeater cannot be accessed.	1 Wrong tone frequency is selected.	1 Press [F] , [TONE] to select a proper repeater access tone.	13
	2 Wrong repeater offset frequency is selected.	2 Access Menu No. 6 (OFFSET) and select an appropriate shift frequency.	12
	3 Wrong shift direction is selected.	3 Try other shift directions.	12
DTMF tone cannot be transmitted.	DTMF Lock is ON.	Access Menu No. 14 (DTMF LOCK) and select "OFF".	32
Repeater does not accept your DTMF tones.	DTMF tone duration is too short.	Access Menu No. 11 (DTMF SPD) and select "SLOW".	32
Transceiver trasmits without pressing the PTT switch.	VOX function is ON.	Press [F] , [SQL] to turn the VOX function OFF.	41
The transceiver switches OFF for no apparent reason.	The Automatic Power Off (APO) function is programmed.	Access Menu No. 18 (APO) and turn the APO function OFF.	36
The output power is reduced and the "H" icon blinks.	The temperature of the transceiver's chassis becomes too high to transmit at high output power. The internal thermal protection circuits lowered the output power level.	Turn the transceiver OFF or let the transceiver cool down in the receive mode for a while.	51
The transceiver returns to receive mode after a long transmission.	The transmission time exceeded 10 minutes.	The built-in time-out timer cancels the transmission if you continuously transmit for over 10 minutes. You cannot turn this function OFF. It is necessary to protect the transceiver from the thermal damage.	40
The scan function does not resume the scanning after the transceiver detects a signal.	You have selected "SEEK" for Menu No. 1 (SCAN RESUME).	Select either "TIME" or "CARRIER" for Menu No. 1 (SCAN RESUME).	27

15 TROUBLESHOOTING

MICROPROCESSOR RESET

If your transceiver seems to be malfunctioning, resetting the microprocessor may solve the problem. The following 3 reset modes are available. When performing the reset, you may lose memory data and stored information. Back up or write down important data before performing the reset.

INITIAL SETTINGS

For each VFO, the factory defaults for the operating frequency and mode are as follows.

- A-band: 144.000 MHz/ FM
- B-band: 440.000 MHz/ FM (TH-F6A)
B-band: 430.000 MHz/ FM (TH-F7E)

The Memory channels have no data stored. Refer to pages 19 and 20 for the Call Channels and Information Channels default values.

VFO RESET

This resets the transceiver parameters excluding the Menu contents and Memory channel contents.

Note: Menu No. 4 (PROG VFO) and No. 6 (OFFSET) return to the factory default values.

MENU RESET

This resets the parameters only in the Menu items to factory default values.

FULL RESET

This resets all transceiver parameters to the factory default values.

PERFORMING RESET

There are 2 ways to enter the reset mode selection. However, the transceiver must be configured to the Lock function OFF {page 38}.

When the transceiver is turned OFF:

- 1 Press **[F]+[⏻]** (POWER).
 - All indicators are lit.
- 2 Release **[F]**.
 - Proceed to step 3 {below}.

From the Menu:

- 1 Press **[MNU]**.
- 2 Turn the **Tuning** control or press **[▲]/ [▼]** to select Menu No. 31 (RESET?). Press **[▶]** or **[MNU]**.
- 3 Select the reset mode by turning the **Tuning** control or press **[▲]/ [▼]**. If you select "NO", the transceiver exits the reset mode.



- 4 Press **[▶]** or **[MNU]** to proceed.
 - If you press any keys, other than **[LAMP]** and **[MONI]**, the transceiver exits the reset mode.
 - A reset confirmation message appears.

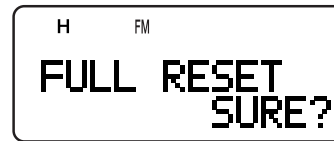

- 5 Press **[▶]** or **[MNU]** to reset the transceiver.
 - If you press any keys, other than **[LAMP]** and **[MONI]**, the transceiver exits the reset mode.

OPERATION NOTICES

The transceiver has been designed and engineered to avoid possible hardware glitches. However, you may notice the following symptoms when you operate the transceiver. These symptoms are not malfunctions.

OPERATING VOLTAGE

As stated in "SPECIFICATIONS" {page 53}, this transceiver operates on a DC voltage from 5.5 V ~ 7.5 V DC (battery terminal) or 12.0 V ~ 16.0 V DC (**DC IN** jack). If you find that the transceiver cannot be switched ON, or "VOLTAGE ERROR" appears, the supplied power source may be outside of the specified range.

In such a case, remove the DC power cable from the transceiver immediately and confirm that the supplied voltage is within the specified range.

TUNING IN SSB/ CW MODE

The transceiver uses a general purpose IF filter to receive signals in LSB, USB, CW and AM modes. So, when you receive signals in LSB or USB mode, the opposite side band signal is not fully attenuated. At the same time, since the same filter is used for CW reception, you may have difficulties separating the CW signal from other signals in the crowded band.

To best tune in to a SSB signal, follow the instruction below.

When you receive signals in USB mode:

- 1 Turn the Fine Tuning function ON {page 35}.
- 2 Tune to the target signal while starting at a lower frequency, using the **Tuning** control.

When you receive signals in LSB mode:

- 1 Turn the Fine Tuning function ON {page 35}.
- 2 Tune to the target signal while starting at a higher frequency, using the **Tuning** control.

RECEIVING IN AM BAND

If you receive a weak signal in AM band, you may notice a high pitched squealing noise in the background. This noise is generated by the internal DC/DC converter and it cannot be removed.

RECEIVING SIGNALS IN CITIES

When you receive signals in cities, the receiver's entire S-meter may light up without receiving any strong signals. This happens when the RF amplifier in the receiver is overloaded by strong interference signals that are nearby. In this case, turn the Attenuator function ON {page 36} to reduce the interference signal level. You may further have to adjust the volume level while receiving the target signal.

BEAT AND NOISE

When you have the same 2 m, 1.25 m (TH-F6A only), and 70 cm band frequencies for both A and B-band receivers, the Visual Scan may indicate the signals on the bar-graph display even if no signal is monitored on the A-band receiver. This error occurs due to the internal spurious harmonics that are generated by the B-band-receiver. Refer to "INTERNAL BEATS" {below} for the frequencies.

You may also hear some noise in the receiving signal in the following cases.

- You perform any scan on the other receiver.
- You perform the Visual Scan on the B-band receiver.

TRANSMISSION

If you continuously transmit for more than 3 minutes at high power (5 W), the transceiver becomes warm. If you continue or repeat the transmission before the transceiver cools down, the thermal protector automatically decreases the output power to 0.5 W. "H" also blinks at the same time. If this happens, let the transceiver cool down for a while before transmitting again.

INTERNAL BEATS

If one of the formulas on the next page is true, the S-meter moves without receiving any signals or you cannot receive any signals. This is inevitable when you use superheterodyne receivers.

SPECIFICATIONS

General		TH-F6A	TH-F7E
Number of memory channels		400 channels + 35 special function memories	400 channels + 34 special function memories
Antenna impedance (Connector type)		50Ω (SMA)	
Operating Voltage	DC IN jack	DC 12.0 ~ 16.0 V (13.8 V nominal)	
	Battery terminal	DC 5.5 ~ 7.5 V (7.4 V nominal)	
Grounding method		Negative ground	
Current	Transmit with H, 13.8 V (DC IN)	2.0 A or less	
	Transmit with H, 7.4 V (PB-42L)	2.0 A or less	
	Transmit with L, 7.4 V (PB-42L)	0.8 A or less	
	Transmit with EL, 7.4 V (PB-42L)	0.5 A or less	
	Receive (no signal)	100 mA (single band)/ 170 mA or less (dual-band)	
	Battery Saver ON (Average)	30 mA (single band)/ 35 mA or less (dual-band)	
Usable temperature range		-20°C ~ 60°C (-4°F ~ 140°F) -10°C ~ 50°C (+14°F ~ 122°F) with PB-42L	
Frequency stability		Within ±8ppm (-20°C ~ 60°C) Within ±5ppm (-10°C ~ 50°C)	
Dimensions (W x H x D Projections not included)		58 x 87 x 30 mm/ 2.3" x 3.4" x 1.2" with the PB-42L 58 x 87 x 38 mm/ 2.3" x 3.4" x 1.5" with the BT-13	
Weight		Approx. 250 g/ 0.55 lb with the PB-42L Approx. 280 g/ 0.62 lb with the BT-13	

Transmitter			TH-F6A	TH-F7E
Transmit Mode			F3E (FM)/ F2D (FM)	
Frequency range	2 m band		144 ~ 148 MHz	144 ~ 146 MHz
	1.25 m band		222 ~ 225 MHz	N/A
	70 cm band		430 ~ 450 MHz ¹	430 ~ 440 MHz
Output Power	2 m band/ 1.25 m band/ 70 cm band	DC IN jack (13.8 V)	H: 5.0 W (approx.) L: 2.0 W (approx.) EL: 0.5 W (approx.)	
		PB-42L (7.4 V)	H: 5.0 W (approx.) L: 0.5 W (approx.) EL: 0.05 W (approx.)	
		BT-14 (6.0 V)	H: 0.5 W (approx.) L: 0.3 W (approx.) EL: 0.05 W (approx.)	
Modulation			Reactance	
Maximum frequency deviation			±5 kHz (FM)/ ±2.5 kHz (NFM)	
Spurious emissions (at high transmit power)			-60 dB or less	
Microphone impedance			2kΩ	

¹ Specifications are guaranteed within 438 ~ 450 MHz.

16 SPECIFICATIONS

Receiver		TH-F6A	TH-F7E
Receive mode	A-band	F3E (FM)/ F2D (FM)/ F1D (FM)	
	B-band	J3E (LSB, USB)/ A1A (CW): 0.1 MHz ≤ f < 470 MHz A3A (AM)/ F3E (FM)/ F2D (FM): 0.1 MHz ≤ f < 1.3 GHz	
Circuit type	LSB/ USB/ CW/ AM/ FM	Double superheterodyne	
	WFM	Single superheterodyne	
Frequency range	A-band	137 ~ 174 MHz 216 ~ 260 MHz 410 ~ 470 MHz	144 ~ 146 MHz 430 ~ 440 MHz
	B-band	0.1 ~ 1.8 MHz 1.8 ~ 29.7 MHz 29.7 ~ 54 MHz 54 ~ 108 MHz 108 ~ 137 MHz 137 ~ 174 MHz 174 ~ 216 MHz 216 ~ 400 MHz 400 ~ 470 MHz 470 ~ 806 MHz 806 ~ 824 MHz 849 ~ 869 MHz 894 ~ 1300 MHz	0.1 ~ 1.71 MHz 1.71 ~ 29.7 MHz 29.7 ~ 87.5 MHz 87.5 ~ 108 MHz 108 ~ 137 MHz 137 ~ 174 MHz 174 ~ 230 MHz 230 ~ 400 MHz 400 ~ 470 MHz 470 ~ 862 MHz 862 ~ 1300 MHz
Intermediate Frequency (IF)	A-band	1st IF: 59.85 MHz 2nd IF: 450 kHz	
	B-band	1st IF 0.1 MHz ~ 1.3 GHz: 57.60 MHz (LSB/ USB/ CW/ AM/ FM) 29.7 MHz ~ 1.3 GHz: 10.8 MHz (WFM) 2nd IF 0.1 MHz ~ 1.3 GHz: 450 kHz (LSB/ USB/ CW/ AM/ FM)	
Sensitivity	A-band	FM (12 dB SINAD) 2m/ 1.25 m (TH-F6A only)/ 70 cm amateur radio bands: 0.18 μV or less	
	B-band	FM (12 dB SINAD) 5 ~ 108 MHz: 0.40 μV 118 ~ 144 MHz: 0.28 μV 144 ~ 225 MHz: 0.22 μV 225 ~ 250 MHz: 0.89 μV 380 ~ 400 MHz: 0.40 μV 400 ~ 450 MHz: 0.22 μV 450 ~ 520 MHz: 0.40 μV 520 ~ 700 MHz: 7.08 μV 800 ~ 950 MHz: 1.26 μV 950 ~ 1300 MHz: 0.40 μV WFM (30 dB S/N) 50 ~ 108 MHz: 3.16 μV 150 ~ 222 MHz: 2.82 μV 400 ~ 500 MHz: 3.98 μV	AM (10 dB S/N) 0.3 ~ 0.52 MHz: 7.08 μV 0.52 ~ 1.8 MHz: 2.24 μV 1.8 ~ 50 MHz: 0.89 μV 118 ~ 250 MHz: 0.40 μV 380 ~ 500 MHz: 0.40 μV LSB/ USB (10 dB S/N) 3 ~ 30 MHz: 0.45 μV 30 ~ 50 MHz: 0.40 μV 144 ~ 148 MHz: 0.22 μV 430 ~ 450 MHz: 0.22 μV * All values are approximate
Squelch sensitivity		0.13 μV or less (within 2m/ 1.25 m/ 70 cm amateur radio bands)	
Selectivity		-6 dB/ 12 kHz or less -40 dB/ 28 kHz or less (within 2m/ 1.25 m/ 70 cm amateur radio bands)	
Audio output (10% distortion)		300 mW or higher (7.4 V, 8Ω load)	

APPENDIX

TV CHANNELS (VHF)

U. S. A.

CH No.	V Freq. (MHz)	A Freq. (MHz)
2	55.25	59.75
3	61.25	65.75
4	67.25	71.75
5	77.25	81.75
6	83.25	87.75
7	175.25	179.75
8	181.25	185.75
9	187.25	191.75
10	193.25	197.75
11	199.25	203.75
12	205.25	209.75
13	211.25	215.75

United Kingdom

CH No.	V Freq. (MHz)	A Freq. (MHz)
1	45.00	41.50
2	51.75	48.25
3	56.75	53.25
4	61.75	58.25
5	66.75	63.25
6	179.75	176.25
7	184.75	181.25
8	189.75	186.25
9	194.75	191.25
10	199.75	196.25
11	204.75	201.25
12	209.75	206.25
13	214.75	211.25

France

CH No.	V Freq. (MHz)	A Freq. (MHz)
A	47.75	41.25
B	55.75	49.25
C1	60.50	54.00
C	63.75	57.25
1	176.00	182.50
2	184.00	190.50
3	192.00	198.50
4	200.00	206.50
5	208.00	214.50
6	216.00	222.50

Italy

CH No.	V Freq. (MHz)	A Freq. (MHz)
A	53.75	59.25
B	62.25	67.75
C	82.25	87.75
D	175.25	180.75
E	183.75	189.25
F	192.25	197.75
G	201.25	206.75
H	210.25	215.75
H1	217.25	222.75
H2	224.25	229.75

Western Europe

CH No.	V Freq. (MHz)	A Freq. (MHz)
1	41.25	46.75
2	48.25	53.75
3	55.25	60.75
4	62.25	67.75
5	175.25	180.75
6	182.25	187.75
7	189.25	194.75
8	196.25	201.75
9	203.25	208.75
10	210.25	215.75
11	217.25	222.75
12	224.25	229.75

Ireland

CH No.	V Freq. (MHz)	A Freq. (MHz)
A	45.75	51.75
B	53.75	59.75
C	61.75	67.75
D	175.25	181.25
E	183.25	189.25
F	191.25	197.25
G	199.25	205.25
H	207.25	213.25
J	215.25	221.25

Eastern Europe

CH No.	V Freq. (MHz)	A Freq. (MHz)
1	49.75	56.25
2	59.25	65.75
3	77.25	83.75
4	85.25	91.75
5	93.25	99.75
6	175.25	181.75
7	183.25	189.75
8	191.25	197.75
9	199.25	205.75
10	207.25	213.75
11	215.25	221.75
12	223.25	229.75

French Affiliated Countries

CH No.	V Freq. (MHz)	A Freq. (MHz)
4	175.25	181.75
5	183.25	189.75
6	191.25	197.75
7	199.25	205.75
8	207.25	213.75
9	215.25	221.75

Morocco

CH No.	V Freq. (MHz)	A Freq. (MHz)
4	163.25	168.75
5	171.25	176.75
6	179.25	184.75
7	187.25	192.75
8	195.25	200.75
9	203.25	208.75
10	211.25	216.75

Angola

CH No.	V Freq. (MHz)	A Freq. (MHz)
1	43.25	49.25
2	52.25	58.25
3	60.25	66.25
4	175.25	181.25
5	183.25	189.25
6	191.25	197.25
7	199.25	205.25
8	207.25	213.25
9	215.25	221.25
10	223.25	229.25

South Africa

CH No.	V Freq. (MHz)	A Freq. (MHz)
4	175.25	181.25
5	183.25	189.25
6	191.25	197.25
7	199.25	205.25
8	207.25	213.25
9	215.25	221.25
10	223.25	229.25
11	231.25	237.25
12	—	—
13	247.43	253.43

China

CH No.	V Freq. (MHz)	A Freq. (MHz)
1	49.75	56.25
2	57.75	64.25
3	65.75	72.25
4	77.25	83.75
5	85.25	91.75
6	168.25	174.75
7	176.25	182.75
8	184.25	190.75
9	192.25	198.75
10	200.25	206.75
11	208.25	214.75
12	216.25	222.75

Japan

CH No.	V Freq. (MHz)	A Freq. (MHz)
1	91.25	95.75
2	97.25	101.75
3	103.25	107.75
4	171.25	175.75
5	177.25	181.75
6	183.25	187.75
7	189.25	193.75
8	193.25	197.75
9	199.25	203.75
10	205.25	209.75
11	211.25	215.75
12	217.25	221.75

Indonesia

CH No.	V Freq. (MHz)	A Freq. (MHz)
1A	44.25	49.75
2	55.25	60.75
3	62.25	67.75
4	175.25	180.75
5	182.25	187.75
6	189.25	194.75
7	196.25	201.75
8	203.25	208.75
9	210.25	215.75
10	217.25	222.75
11	224.25	229.75

Australia

CH No.	V Freq. (MHz)	A Freq. (MHz)
0	46.25	51.75
1	57.25	62.75
2	64.25	69.75
3	86.25	91.75
4	95.25	100.75
5	102.25	107.75
5A	138.25	143.75
6	175.25	180.75
7	182.25	187.75
8	189.25	194.75
9	196.25	201.75
10	209.25	214.75
11	216.25	221.75

New Zealand

CH No.	V Freq. (MHz)	A Freq. (MHz)
1	45.25	50.75
2	55.25	60.75
3	62.25	67.75
4	175.25	180.75
5	182.25	187.75
6	189.25	194.75
7	196.25	201.75
8	203.25	208.75
9	210.25	215.75
10	217.25	222.75
11	224.25	229.75

17 APPENDIX

TV CHANNELS (UHF)

U. S. A. / Japan

CH No. (U.S.A.)	CH No. (Japan)	V Freq. (MHz)	A Freq. (MHz)
14	13	471.25	475.75
15	14	477.25	481.75
16	15	483.25	487.75
17	16	489.25	493.75
18	17	495.25	499.75
19	18	501.25	505.75
20	19	507.25	511.75
21	20	513.25	517.75
22	21	519.25	523.75
23	22	525.25	529.75
24	23	531.25	535.75
25	24	537.25	541.75
26	25	543.25	547.75
27	26	549.25	553.75
28	27	555.25	559.75
29	28	561.25	565.75
30	29	567.25	571.75
31	30	573.25	577.75
32	31	579.25	583.75
33	32	585.25	589.75
34	33	591.25	595.75
35	34	597.25	601.75
36	35	603.25	607.75
37	36	609.25	613.75
38	37	615.25	619.75
39	38	621.25	625.75
40	39	627.25	631.75
41	40	633.25	637.75
42	41	639.25	643.75
43	42	645.25	649.75
44	43	651.25	655.75
45	44	657.25	661.75
46	45	663.25	667.75
47	46	669.25	673.75
48	47	675.25	679.75
49	48	681.25	685.75
50	49	687.25	691.75
51	50	693.25	697.75
52	51	699.25	703.75
53	52	705.25	709.75
54	53	711.25	715.75
55	54	717.25	721.75
56	55	723.25	727.75
57	56	729.25	733.75
58	57	735.25	739.75
59	58	741.25	745.75
60	59	747.25	751.75
61	60	753.25	757.75
62	61	759.25	763.75
63	62	765.25	769.75
64		771.25	775.75
65		777.25	781.75
66		783.25	787.75
67		789.25	793.75
68		795.25	799.75
69		801.25	805.75
70		807.25	811.75
71		813.25	817.75
72		819.25	823.75
73		825.25	829.75
74		831.25	835.75
75		837.25	841.75
76		843.25	847.75
77		849.25	853.75
78		855.25	859.75
79		861.25	865.75
80		867.25	871.75
81		873.25	877.75
82		879.25	883.75
83		885.25	889.75

Europe and Africa

CH No.	V Freq. (MHz)	A Freq. (MHz)
21	471.25	476.75
22	479.25	484.75
23	487.25	492.75
24	495.25	500.75
25	503.25	508.75
26	511.25	516.75
27	519.25	524.75
28	527.25	532.75
29	535.25	540.75
30	543.25	548.75
31	551.25	556.75
32	559.25	564.75
33	567.25	572.75
34	575.25	580.75
35	583.25	588.75
36	591.25	596.75
37	599.25	604.75
38	607.25	612.75
39	615.25	620.75
40	623.25	628.75
41	631.25	636.75
42	639.25	644.75
43	647.25	652.75
44	655.25	660.75
45	663.25	668.75
46	671.25	676.75
47	679.25	684.75
48	687.25	692.75
49	695.25	700.75
50	703.25	708.75
51	711.25	716.75
52	719.25	724.75
53	727.25	732.75
54	735.25	740.75
55	743.25	748.75
56	751.25	756.75
57	759.25	764.75
58	767.25	772.75
59	775.25	780.75
60	783.25	788.75
61	791.25	796.75
62	799.25	804.75
63	807.25	812.75
64	815.25	820.75
65	823.25	828.75
66	831.25	836.75
67	839.25	844.75
68	847.25	852.75
69	855.25	860.75

Note: 3 different types exist.

1: V Freq. + 5.5 MHz = A Freq.

(above)

2: V Freq. + 6.0 MHz = A Freq.

3: V Freq. + 6.5 MHz = A Freq.

China

CH No.	V Freq. (MHz)	A Freq. (MHz)
13	471.25	477.75
14	479.25	485.75
15	487.25	493.75
16	495.25	501.75
17	503.25	509.75
18	511.25	517.75
19	519.25	525.75
20	527.25	533.75
21	535.25	541.75
22	543.25	549.75
23	551.25	557.75
24	559.25	565.75
25	607.25	613.75
26	615.25	621.75
27	623.25	629.75
28	631.25	637.75
29	639.25	645.75
30	647.25	653.75
31	655.25	661.75
32	663.25	669.75
33	671.25	677.75
34	679.25	685.75
35	687.25	693.75
36	695.25	701.75
37	703.25	709.75
38	711.25	717.75
39	719.25	725.75
40	727.25	733.75
41	735.25	741.75
42	743.25	749.75
43	751.25	757.75
44	759.25	765.75
45	767.25	773.75
46	775.25	781.75
47	783.25	789.75
48	791.25	797.75
49	799.25	805.75
50	807.25	813.75
51	815.25	821.75
52	823.25	829.75
53	831.25	837.75
54	839.25	845.75
55	847.25	853.75
56	855.25	861.75
57	863.25	869.75
58	871.25	877.75
59	879.25	885.75
60	887.25	893.75
61	895.25	901.75
62	903.25	909.75
63	911.25	917.75
64	919.25	925.75
65	927.25	933.75
66	935.25	941.75
67	943.25	949.75
68	951.25	957.75

Australia

CH No.	V Freq. (MHz)	A Freq. (MHz)
28	527.25	532.75
29	534.25	539.75
30	541.25	546.75
31	548.25	553.75
32	555.25	560.75
33	562.25	567.75
34	569.25	574.75
35	576.25	581.75
36	583.25	588.75
37	590.25	595.75
38	597.25	602.75
39	604.25	609.75
40	611.25	616.75
41	618.25	623.75
42	625.25	630.75
43	632.25	637.75
44	639.25	644.75
45	646.25	651.75
46	653.25	658.75
47	660.25	665.75
48	667.25	672.75
49	674.25	679.75
50	681.25	686.75
51	688.25	693.75
52	695.25	700.75
53	702.25	707.75
54	709.25	714.75
55	716.25	721.75
56	723.25	728.75
57	730.25	735.75
58	737.25	742.75
59	744.25	749.75
60	751.25	756.75
61	758.25	763.75
62	765.25	770.75
63	772.25	777.75
64	779.25	784.75
65	786.25	791.75
66	793.25	798.75
67	800.25	805.75
68	807.25	812.75
69	814.25	819.75

MARINE CHANNELS (VHF)

International

CH No.	Frequency (MHz)	
	TX	RX
1	156.050	160.650
2	156.100	160.700
3	156.150	160.750
4	156.200	160.800
5	156.250	160.850
6	156.300	
7	156.350	160.950
8	156.400	
9	156.450	
10	156.500	
11	156.550	
12	156.600	
13	156.650	
14	156.700	
15	156.750	
16	156.800	
17	156.850	
18	156.900	161.500
19	156.950	161.550
20	157.000	161.600
21	157.050	161.650
22	157.100	161.700
23	157.150	161.750
24	157.200	161.800
25	157.250	161.850
26	157.300	161.900
27	157.350	161.950
28	157.400	162.000

CH No.	Frequency (MHz)	
	TX	RX
60	156.025	160.625
61	156.075	160.675
62	156.125	160.725
63	156.175	160.775
64	156.225	160.825
65	156.275	160.875
66	156.325	160.925
67	156.375	
68	156.425	
69	156.475	
70	156.525	
71	156.575	
72	156.625	
73	156.675	
74	156.725	
76	156.825	
77	156.875	
78	156.925	161.525
79	156.975	161.575
80	157.025	161.625
81	157.075	161.675
82	157.125	161.725
83	157.175	161.775
84	157.225	161.825
85	157.275	161.875
86	157.325	161.925
87	157.375	161.975
88	157.425	162.025

U. S. A.

CH No.	Frequency (MHz)	
	TX	RX
1	156.050	
5	156.250	
6	156.300	
7	156.350	
8	156.400	
9	156.450	
10	156.500	
11	156.550	
12	156.600	
13	156.650	
14	156.700	
15	156.750	
16	156.800	
17	156.850	
18	156.900	
19	156.950	
20	157.000	161.600
21	157.050	
22	157.100	
23	157.150	
24	157.200	161.800
25	157.250	161.850
26	157.300	161.900
27	157.350	161.950
28	157.400	162.000

CH No.	Frequency (MHz)	
	TX	RX
63	156.175	
64	160.825	
65	156.275	
66	156.325	
67	156.375	
68	156.425	
69	156.475	
70	156.525	
71	156.575	
72	156.625	
73	156.675	
74	156.725	
77	156.875	
78	156.925	
79	156.975	
80	157.025	
81	157.075	
82	157.125	
83	157.175	
84	157.225	
85	157.275	161.875
86	157.325	161.925
87	157.375	161.975
88	157.425	

Canada

CH No.	Frequency (MHz)	
	TX	RX
1	156.050	160.650
2	156.100	160.700
3	156.150	160.750
4	156.200	
5	156.250	
6	156.300	
7	156.350	
8	156.400	
9	156.450	
10	156.500	
11	156.550	
12	156.600	
13	156.650	
14	156.700	
15	156.750	
16	156.800	
17	156.850	
18	156.900	
19	156.950	
20	157.000	161.600
21	157.050	
22	157.100	
23	157.150	161.750
24	157.200	161.800
25	157.250	161.850
26	157.300	161.900
27	157.350	161.950
28	157.400	162.000

CH No.	Frequency (MHz)	
	TX	RX
60	156.025	160.625
61	156.075	
62	156.125	
63	156.175	
64	156.225	160.825*
65	156.275	
66	156.325	
67	156.375	
68	156.425	
69	156.475	
70	156.525	
71	156.575	
72	156.625	
73	156.675	
74	156.725	
76	156.825	
77	156.875	
78	156.925	
79	156.975	
80	157.025	
81	157.075	
82	157.125	
83	157.175	
84	157.225	
85	157.275	161.875
86	157.325	161.925
87	157.375	161.975
88	157.425	162.025

* Pacific coast only

CITIZEN BAND CHANNELS

U. S. A.

CH No.	Frequency (MHz)
1	26.965
2	26.975
3	26.985
4	27.005
5	27.015
6	27.025
7	27.035
8	27.055
9	27.065
10	27.075
11	27.085
12	27.105
13	27.115
14	27.125
15	27.135
16	27.155
17	27.165
18	27.175
19	27.185
20	27.205

CH No.	Frequency (MHz)
21	27.215
22	27.225
23	27.255
24	27.235
25	27.245
26	27.265
27	27.275
28	27.285
29	27.295
30	27.305
31	27.315
32	27.325
33	27.335
34	27.345
35	27.355
36	27.365
37	27.375
38	27.385
39	27.395
40	27.405

A-band	6	Frequency Step Size	37	Reprogramming	
All-channel Scan	24	Full Reset	50	the Call Channel	19
Alkaline Batteries, Installing	1	Groups, Memory Channel	18	the Information Channel	20
APO (Auto Power OFF)	36	Information Channel		Reset	
AM	34	Recalling	20	Full	50
AM Band	33, 34	Reprogramming	20	Menu	50
ASC	14	Scan	26	VFO	50
Attenuator	36	Installing		Reverse Function	14
Automatic Dialer	31	the Alkaline Batteries	1	Scan	
Automatic Repeater Offset	13	the Antenna	1	All-Channel	24
Automatic Simplex Check	14	the Belt Clip	1	Band	22
B-band Frequency	6, 33	the Li-ion Battery Pack	1	Call	25
Band Scan	22	Internal Beats	51	Carrier-operated Mode	27
Bar Antenna	34	Keys and Control	4	Group	24
Battery		Language, Selecting a Menu	9	Program	23
Installing the Alkaline	1	Lamp	38	Resume Method	27
Installing the Li-ion, pack	1	Li-ion Battery Pack		Seek Mode	27
Life	36	Installing	1	Time-operated Mode	27
Remaining	36	Charging	2	Visual	26
Saver	37	Lock Function	38	Simplex	
Type	36	Manual Dialing	31	Storing, Frequencies or Standard	
Beat Shift	37	Marine Channels, VHF	57	Repeater Frequencies	15
Beep Function	37	Memory Channel		Specifications	53, 54
Belt Clip, Installing the	1	Groups	18	Squelch, Adjusting	6
Call Channel, Recalling	19	Group Link	24	Supplied Accessories	i
Call Scan	25	Lockout	27	SP/MIC jack Function	45
Carrier-operated Mode	27	Naming a	17	Switching Power ON/ OFF	3, 6
Channel Display	21	Recall Mode	16	Time-operated Mode	27
Charging the Li-ion Battery Pack ...	2	Transfer	18	Time-out Timer	40
Cigarette Lighter Socket	2	Menu		TNC	45
Citizen Band Channels	57	Access	9	Tone	
COM Port	46	Function List	9	Activating, Function	13
CTCSS		Reset	50	Freq. ID Scan	14
Freq. ID Scan	29	Meter	5	Selecting a, Frequency	13
Selecting a, Frequency	28	MHz Mode	7	Transmit a 1750 Hz	13
Using	28	MHz Scan	23	Transmitting	7
CW	34, 51	Microphone PF Keys (optional) ...	38	Transmit Power, Selecting	7, 41
DC IN jack	2, 51	Microprocessor Reset	50	Troubleshooting	48, 49
DCS		Monitor	39	Tune Enable	38
Code ID Scan	30	Narrow Band FM Operation	39	TV Channels	55, 56
Selecting a, Code	29	Normal Scan	22	TX Inhibit	40
Using	29	Odd-split Frequency	12, 15	TX Power	41
Delete		Offset		USB	34
Memory Channel	16	Programming	12	VFO	
Memory Group	18	Programming Flow	12	Mode	7
Direct Frequency Entry	7	Selecting, Direction	12	Programmable	39
Display		Selecting, Frequency	12	Reset	50
LCD	5	Operating Voltage	2, 51	Visual Scan	
Contrast	37	Optional Accessories	44	(Memory channel)	27
DTMF		Output Power		(VFO)	26
Adjusting the Pause		Selecting	7, 41	Volume	
Duration	32	Power ON/ OFF	3, 6	Adjusting	6
Adjusting the, Tone Transmission		Priority Channel		Balance	41, 46
Speed	32	Programming	25	VOX (Voice-Operated Transmit)	
Automatic Dialer	31	Using, Scan	25	Delay Time	42
Manual Dialing	31	Priority Scan	25	Gain	41
Lock	32	Program Scan	23	On busy	42
Storing a, Number		Storing, Frequency Range	23		
in memory	31	Programmable VFO	39	1750 Hz, Transmitting a	13
Transmitting a Stored,		Recalling		9600 bps	45
Number	32	Call Channel	19		
TX hold	31	Memory Channel	16		
Fine Tuning		Information Channel	20		
Activating	35	Regulated Power Supply	2		
Selecting, Frequency Step	35	Repeater Offset, Automatic	13		
First QSO	3	Repeater Operation	12		
FM	34				

KENWOOD